

Perfect[®]
working solution



THE
COLLECTION

Perfect[®]
Group

Perfect Office Furniture Co., Ltd.
196 Rama 2 Rd., Samaedam, Bangkhunthien,
Bangkok 10150 Thailand

T : +66 2895 6301-7 F : +66 2416-0997, +66 2895-7961
W : www.perfect-furniture.com
E : info@perfect-furniture.com

Perfect, a company stimulating its customers

Perfect Office Furniture Co., Ltd. is the manufacturer and distributor of PERFECT Office Furniture with high quality and distinguished modern designs. The company has dedicated itself exclusively to the office environment, developing a cleverness in order to understand and anticipate products that will satisfy all of our customers' requirements. Ergonomic research and quality of the workplace has always been the philosophical base that has made PERFECT Office Furniture one of the leading companies in office furniture products. Our products are designed to conform to international standards, using the best available resources in the market.

We also wish to emphasize our commitment to the customer through our after-sales support. While our products feature durability and ease of maintenance, we also give due consideration to areas like product warranty, availability of replacement components, stocking and delivery programs. Finally, we would like to express our commitment in constantly seeking ways to serve our customers more effectively while moving steadily toward the future.

With 20 years experience and efficiency in manufacturing, PERFECT OFFICE FURNITURE has gained the trust from governments, state enterprises, private individuals, laboratories, hospitals, educational institutions, designers and architects to produce and to deliver all of their office furniture needs.

With the continuous development of our products, excellent office equipment, and committed staff, we strive for excellence in service: We have been awarded for our high quality products through local and international organizations.

Our Evolution

Perfect Office Furniture was established in 1990 by Mr. Pornchai Pataraplapan. The company was established with a full array of high-tech manufactured office furniture, including items made of particle board, MDF board and steel. Our products and showrooms are meant to inspire all of the senses and imagination of our elite customers and designers, and strive to meet your requirements.

Head office

Perfect Office Furniture Co.,Ltd.
 Address : 196, Soi Thakam 12, Rama 2 Rd.,
 Samaedam, Bangkhunthien,
 Bangkok 10150 Thailand
 Tel. 02 895-6301-7
 Fax. 02 416-0997, 02 895-7961
 Website : www.perfect-furniture.com
 E-mail : info@perfect-furniture.com



Executive HI-GLOSS

Implicit and concise fashion

Our focus is on superior quality and practical functioning by gathering the tastes and needs of senior executives. Our products are featured with an elegant appearance, modular design, have multiple functions and are in unique taste, Satisfying you with every single detail.

Real
Veneer

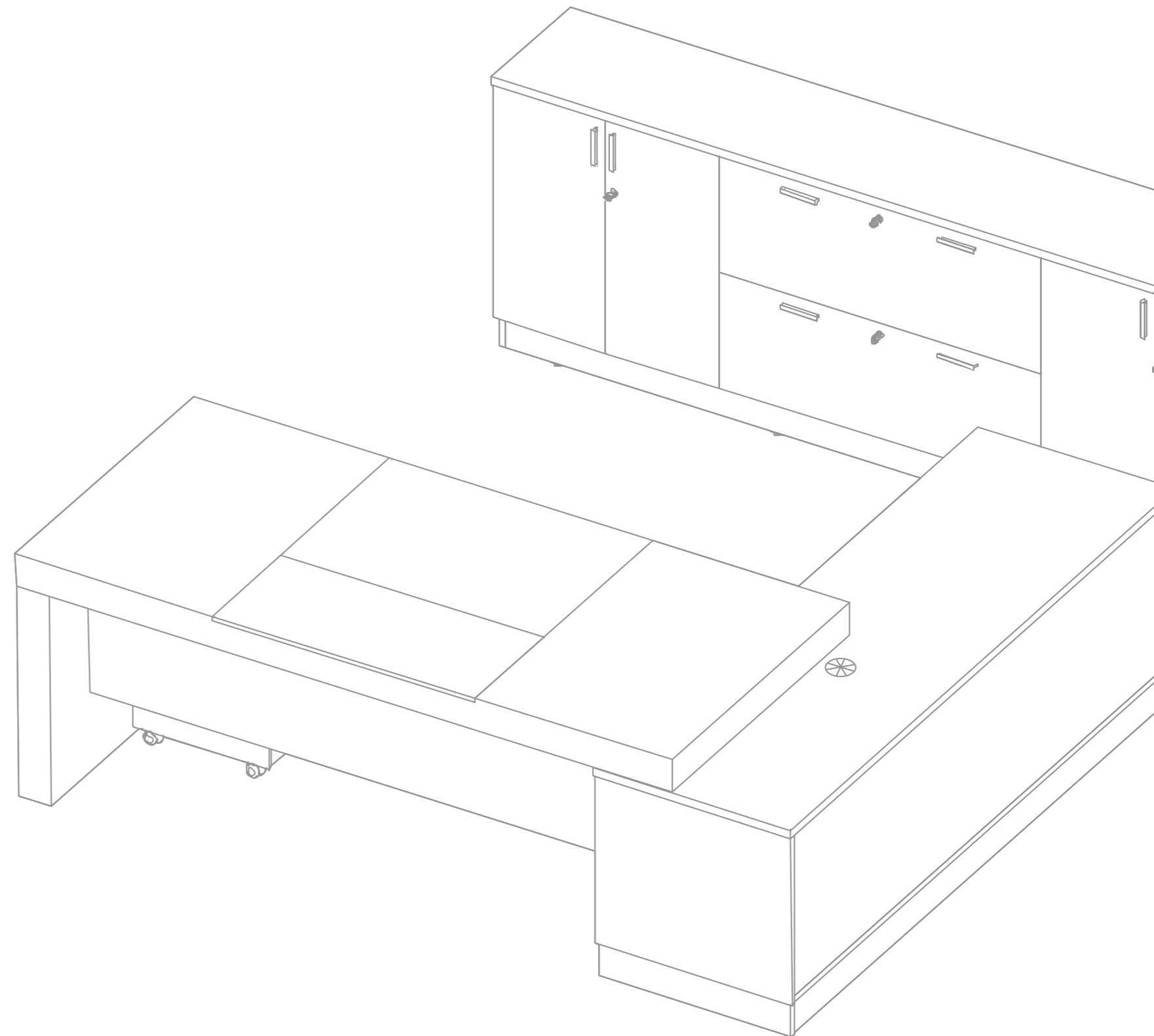

SURFACE Superior Aspired Leader



IMPLICIT and CONCISE FASHION

Combining a modern and elegant outlook with a fine wenge glossy finish, the Surface fully shows the dignity and status of young and dynamic executives. The Surface series also provides a matching conference table, filing cabinet and mobile pedestal to suit your personal tastes and requirements.



Drawer



Keyboard tray



Multifunction outlet (Option)



Wire management



Side cabinet



Wenge Glossy White Matted

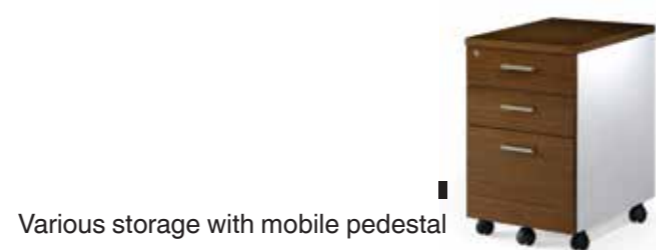

Various storage with mobile pedestal

Executive Set

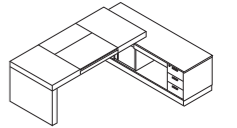

SF-TBR
W236 x D195 x H75 cm.

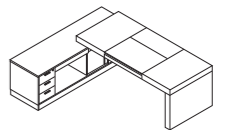

SF-TBL
W236 x D195 x H75 cm.

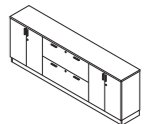

SF-SB
W236 x D40 x H85 cm.



SF-MB
W42 x D52 x H66 cm.



Executive Conference Set

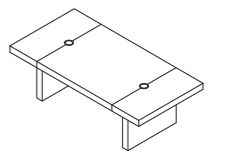

SF-CFR
W240 x D120 x H75 cm.



Hi-Gloss Executive-Set

HARMONY & CASUAL SIMPLICITY



Real veneer

ES-13



Real veneer

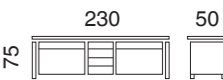
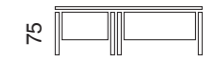
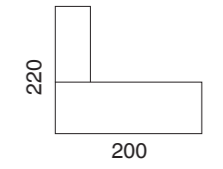

Our focus is on superior quality and practical functioning, by gathering the tastes and needs of senior executives. Our products are featured with an elegant appearance, modular design, have multiple functions and are unique in taste, satisfying you with every single detail.

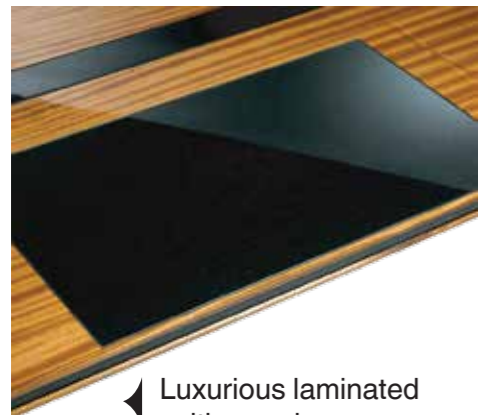

Luxurious laminated writing pad

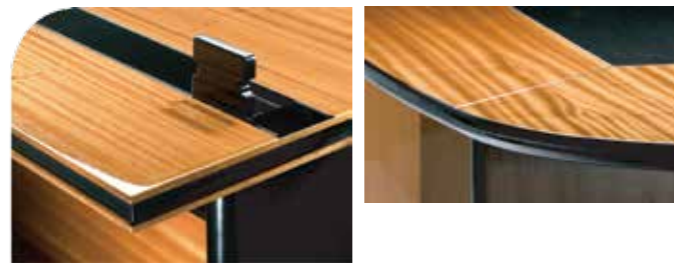

Power outlet design for electrical appliances



Mahogany



Black



Various storage with mobile pedestal

ES-8



Real veneer

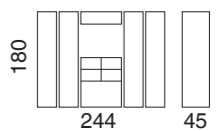
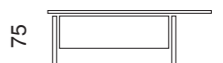
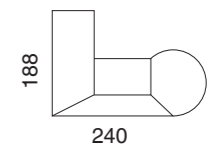

We combine natural beauty and modern design into one unique style.

Hi-Gloss Executive-Set

ES-20



Real veneer

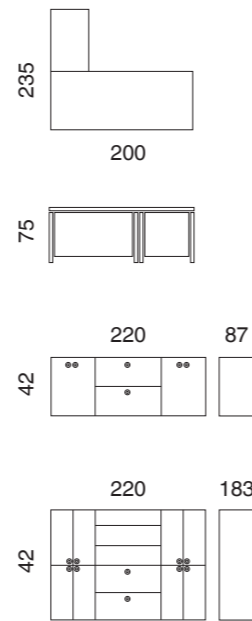

The fundamental theory of furniture design can be intensively seen in the aesthetic office relationship between functionality and form, functionality and ergonomics, and functional and technological materials.

ES, ESR

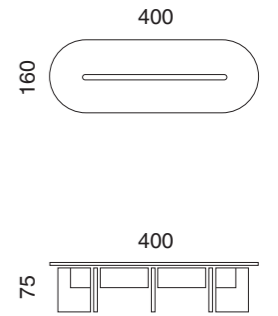

Large and oblong office desks are specially designed to address various changes in office space and provide multi-directional choices for decision makers.

ES-9



Real veneer

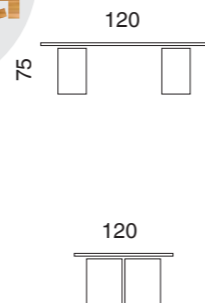

The Conference Table is suitable for any type of meeting. Its natural wood shade suggests harmony and familiarity, the ideal mood for today's result-focused discussion venues.

ES-17



Real veneer

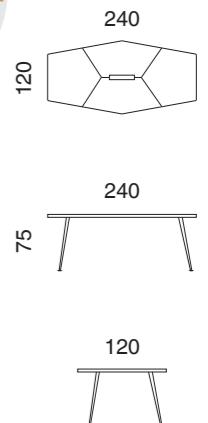

Humane and considerate craftsmanship matches modern shopping concepts, bringing an ideal and wise choice for you. Remarkable conference space gives you a joy in business negotiation, and more importantly the joy of success.

Executive DESK

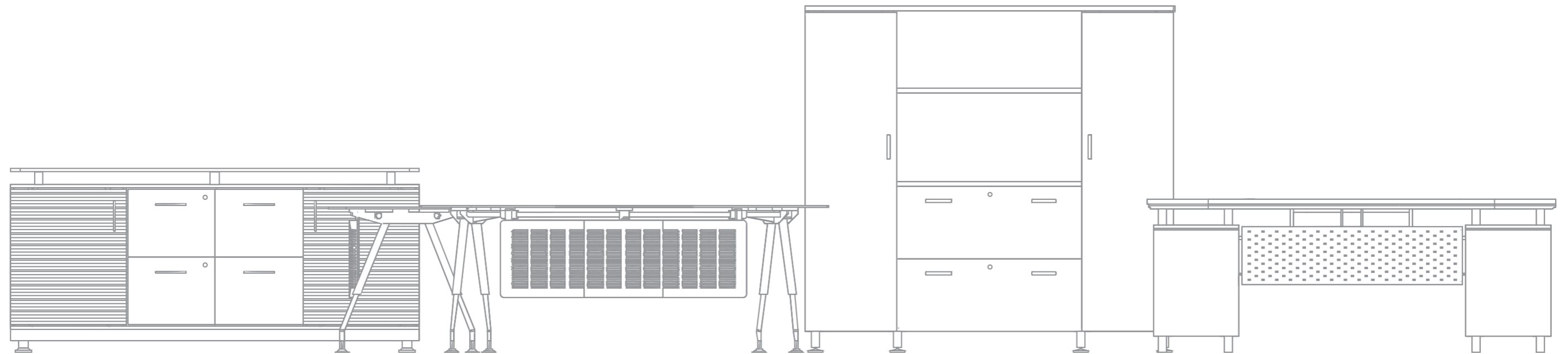

ACER TWO-TONE

Luxurious Stylish

It is worth the wait to have the structural strenght and modern look. "The high class level of design... reflects well on the leadership of your", feel the luxury atmosphere in a private office.

Modern design, for any Executive;
Modern elegant style and function to seamlessly fit your style.



Working Desk without Drawers
EAC-200/G
W200 x D100 x H75 cm.



Sideboard
EA/SB-200
W200 x D46 x H90 cm.



Return Desk without Drawers
EA/RT-140/G
W140 x D70 x H75 cm.



CPU-Mobile
ACPU/W

Specification

Work Top	12 mm. tempered coated glass top / MDF. Board 26 mm.
Panel	Particle Board 19, 16, 12, 6 mm.
Handles	Aluminium Extrusion, Silver Finished
A Leg	Metal sheet press forming, steel tube epoxy paint with extruded tapered chromed steel tube
Modesty	Perforated metal sheet 1 mm.

Work Surface Color



Black (Metallic Paint)

ATHENS Simple and graceful design



All purpose back cabinet



New and modern design with Modesty Panel

Specification	
Panel	MDF Board with Polyester Paint
SidePanel	Particle board 16 mm. Short cycle laminated with Melamine Resin Film
Modesty Panel	Perforated steel 1 mm. Epoxy Powder Coated

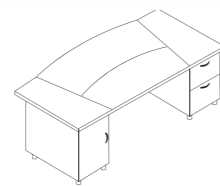

AT 200
W200 x D100 x H75 cm.

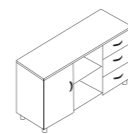

120 ATS
W120 x D45 x H70 cm.

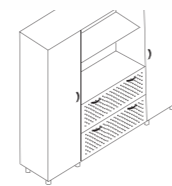

ATS 181
W181 x D40 x H166 cm.



White Matted Black

EST Simple and elegant style

EST is a series in an executive, simple and elegant style designed by two-toned double tops for added durability.

Furthermore, it is combined with wood and chrome, giving a classic and modern look, with more details in the design including a perforated modesty panel.



Keyboard Tray



Writing pad and wire channel







Modesty Panel

Specification

Panel	Particle board 19 mm. with High Pressure Laminate
Second Panel	MDF Board 25 mm. PVC membrane 0.35 mm.
Modesty Panel	Perforate steel sheet with Epoxy Powder Coating
Leg	Chromed round tube 51 mm.
Handles	Aluminium Extrusion / Silver
Runner Drawers	Hafele / Germany

Material

■ Top		■ MB	
			
Cherry G17	Beech G26	Black G20	Graphite G25



Pedestal
653-EST
W41 x D60 x H67 cm.



Return desk with slide door
120-EST
W120 x D48 x H70 cm.



Side board
EST-SB-180
W180 x D48 x H82 cm.
EST-SB-200
W200 x D48 x H82 cm.

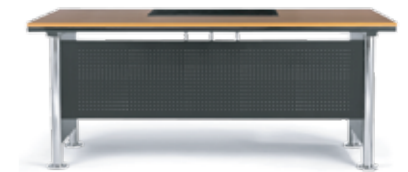

Executive Desk
EST-180
W180 x D90 x H75 cm.
EST-200
W200 x D90 x H75 cm.

EXECUTIVE DESK



PRIME-180/L
W.180 x D.180 x H.75 cm
PRIME-180/R
W.180 x D.180 x H.75 cm
PRIME-200/L
W.200 x D.180 x H.75 cm
PRIME-200/R
W.200 x D.180 x H.75 cm

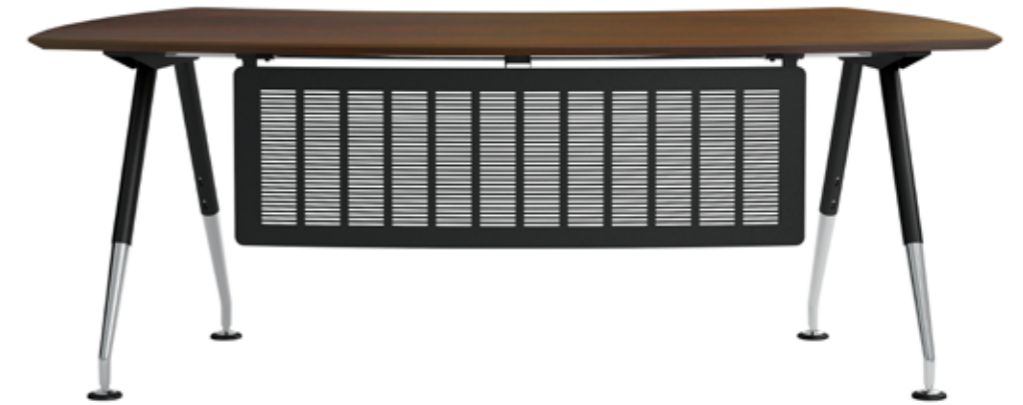

EAC-200/W
W.200 x D.100 x H.75 cm



EA/MB-652
W.41.6 x D.61 x H.61.5 cm



PRIME-SB180
W.180 x D.40 x H.85 cm



EA/RT-140/W
W.140 x D.70 x H.75 cm



EA/SB-200
W.200 x D.50 x H.95 cm

EXECUTIVE DESK



A Square-200
W.200 x D.100 x H.75 cm



A Square-181
W.181 x D.40 x H.166 cm



A Square-120
W.120 x D.45 x H.70 cm



ES9-240
W.240 x D.120 x H.75 cm
ES9-300
W.300 x D.120 x H.75 cm
ES9-400
W.400 x D.130 x H.75 cm

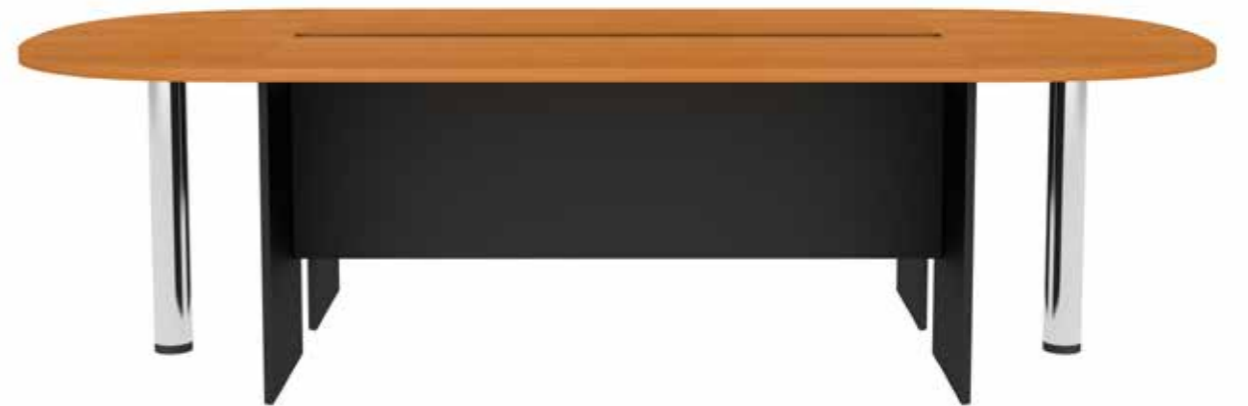

ESS-270
W.270 x D.120 x H.75 cm
ESS-330
W.330 x D.120 x H.75 cm

EXECUTIVE DESK



ESP-270
W.270 x D.120 x H.75 cm
ESP-330
W.330 x D.120 x H.75 cm

NOBLE-UP Executive



NOBLE-UP Conference

The warmth of leather is attached to the shine of polished stainless and anodized aluminium finish, creating both a modern and prestigious style.



EXECUTIVE TABLE

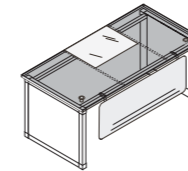

D90			
Dimension	W180 x D90 x H75	NBU 1890+NBMD-140	Material HARD PVC BLACK
	200 x 90 x 75	NBU 2090+NBMD-140	HARD PVC BLACK

RETURN UNIT

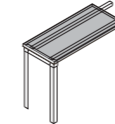

D45			
Dimension	W100 x D45 x H75	NBU-RT 1050L	Material HARD PVC BLACK

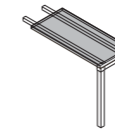

D45			
Dimension	W100 x D45 x H75	NBU-RT 1050R	Material HARD PVC BLACK

PEDESTAL



D50			
Dimension	W39.5 x D50 x H66.5	NBU-L 673	Material HPL

SIDE CABINET

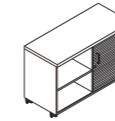

D50			
Dimension	W120 x D50 x H65	NBU 655 SP	Material HPL

CABINET

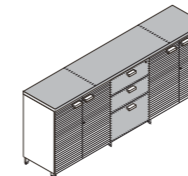

D45			
Dimension	W222 x D45 x H84	NBU 248 SC	Material HPL

CONFERENCE TABLE WITHOUT POP UP

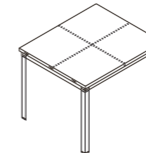

D110			
Dimension	W110 x D110 x H75	NBU-CO 1100	Material HARD PVC BLACK

CONFERENCE TABLE WITHOUT POP UP

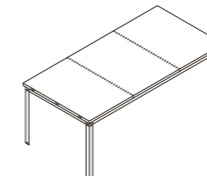

D110			
Dimension	W200 x D110 x H75	NBU-CO 2011	Material HARD PVC BLACK
	240 x 110 x 75	NBU-CO 2411	HARD PVC BLACK

CONFERENCE TABLE WITH POP UP

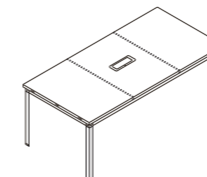

D110			
Dimension	W200 x D110 x H75	NBU-CO 2011K	Material HARD PVC BLACK
	240 x 110 x 75	NBU-CO 2411K	HARD PVC BLACK

WORKSTATION

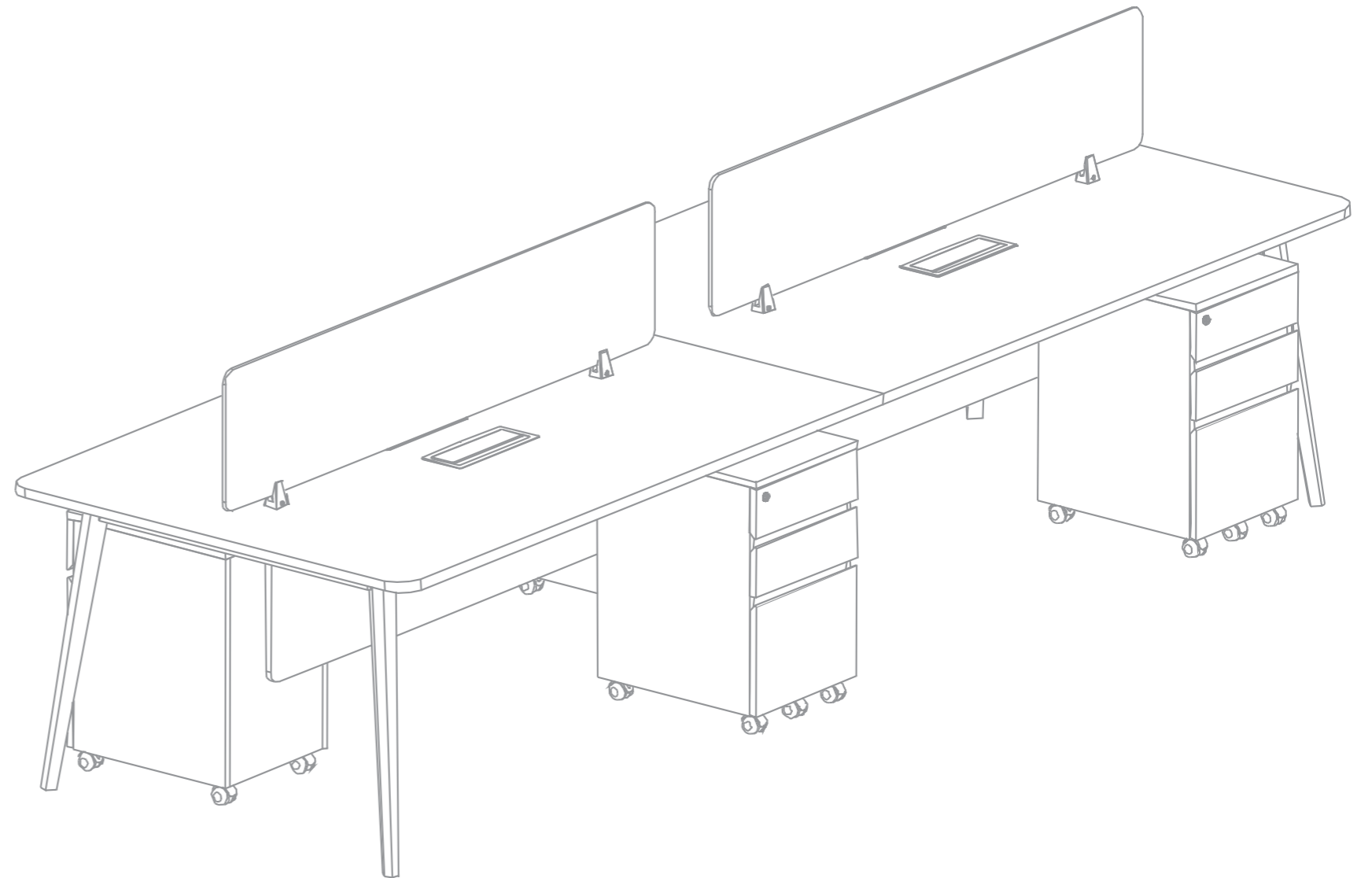

Route Concept

โต๊ะทำงานเปรียบเสมือนเส้นทางสู่ความสำเร็จ ด้วยประเภทของงานและอาชีพที่มีความหลากหลายความต้องการในการใช้งานในรูปแบบต่างๆ ก็เพิ่มมากขึ้นตาม

Route ชุดโต๊ะทำงานที่ถูกออกแบบใหม่ให้ตรงกับความต้องการของสำนักงานสมัยใหม่ที่เน้นชุดโต๊ะทำงานให้ดูโดดเด่นภายใต้แนวความคิดที่ใส่ความยืดหยุ่นและความเชื่อมโยงให้แก่โต๊ะทำงานกับพื้นที่ใช้สอยให้มีอิสระมากขึ้น อีกทั้งยังรองรับการทำงานได้ครอบคลุมทุกรูปแบบที่ต้องการ

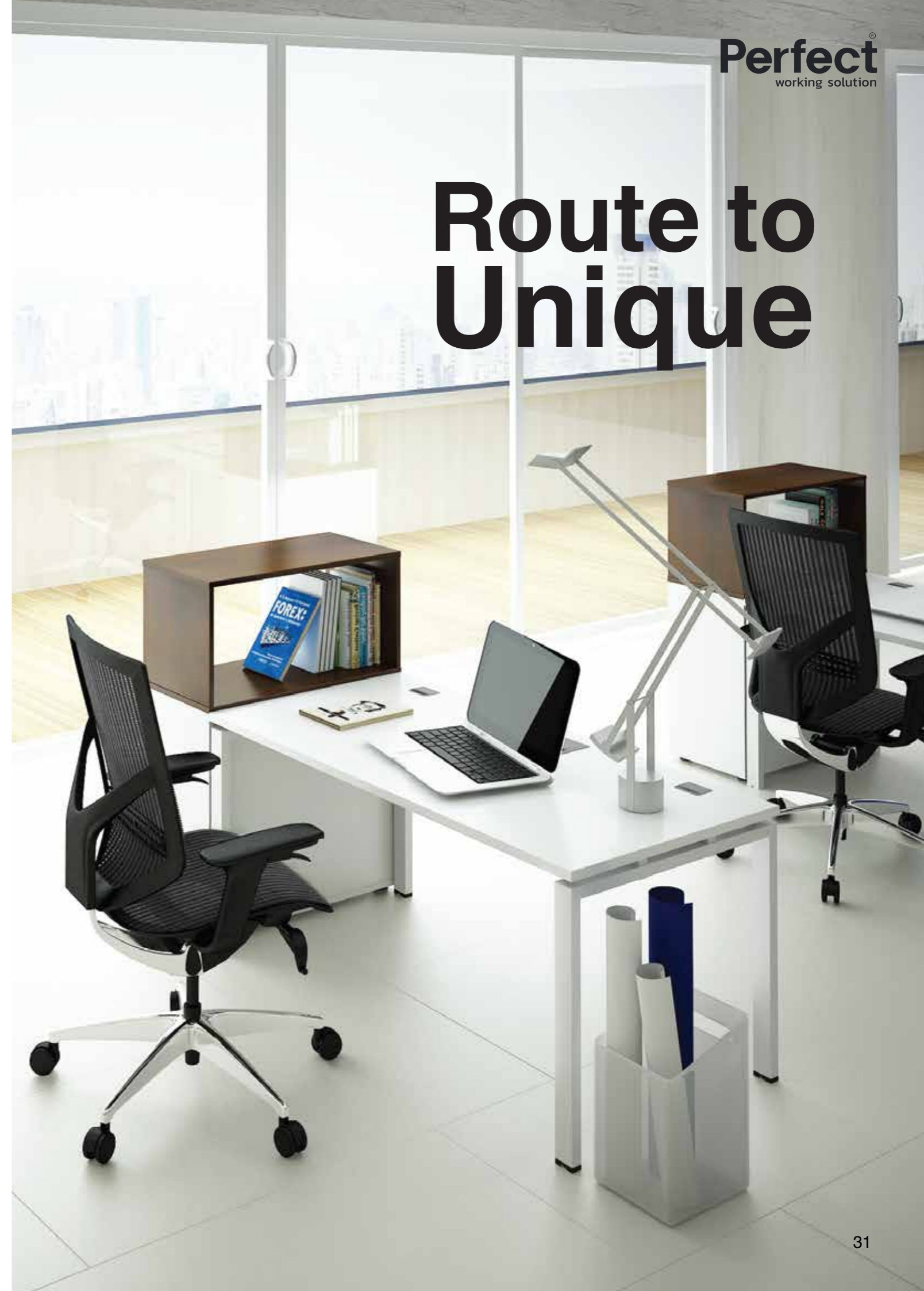
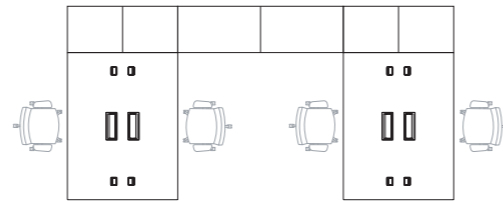
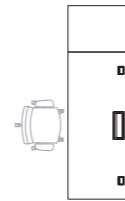

Route to Unique



Privacy benching

Hot desk

การจัดโต๊ะทำงานสมัยใหม่ ที่สามารถใช้พื้นที่ได้อย่างคุ้มค่าที่สุดและใช้งานได้อย่างสะดวกสบายและปลอดภัย



Duo workstation

คู่หูหรือเพื่อนคู่คิดในการทำงานจะช่วยให้ทำงานมีประสิทธิภาพและทำให้งานมีคุณภาพมากยิ่งขึ้น ชุดโต๊ะทำงานแบบหันหน้าชนกัน จะช่วยรองรับการทำงานให้สามารถปรึกษากันได้ทุกเมื่อที่ต้องการ

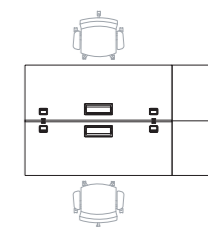

Manager desk

การทำงานในพื้นที่ที่เพิ่มขึ้นด้านข้างช่วยเพิ่มประสิทธิภาพในการจัดการงานได้มากขึ้น มีพื้นที่สำหรับวางเอกสาร ทำให้คล่องตัวในการจัดการเอกสาร พื้นที่โปร่งด้านล่างช่วยเปลี่ยนอิริยาบถที่เมื่อยล้าจากการนั่งทำงานนานๆ ได้อย่างอิสระ

Route

Hamoniously

ความสามัคคีหรือความเป็นอันหนึ่งอันเดียวกันจะช่วยให้ผลงานที่ออกมามีประสิทธิภาพ ชุดเฟอร์นิเจอร์ที่เข้ามารองรับการทำงานในทุกรูปแบบพฤติกรรมให้กลมกลืน ก็จะเปรียบเสมือนเส้นทางสู่ความสำเร็จ

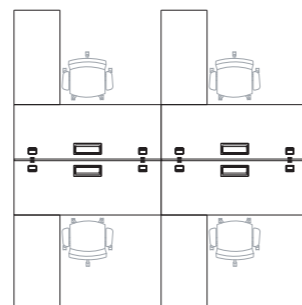

Route to Harmony

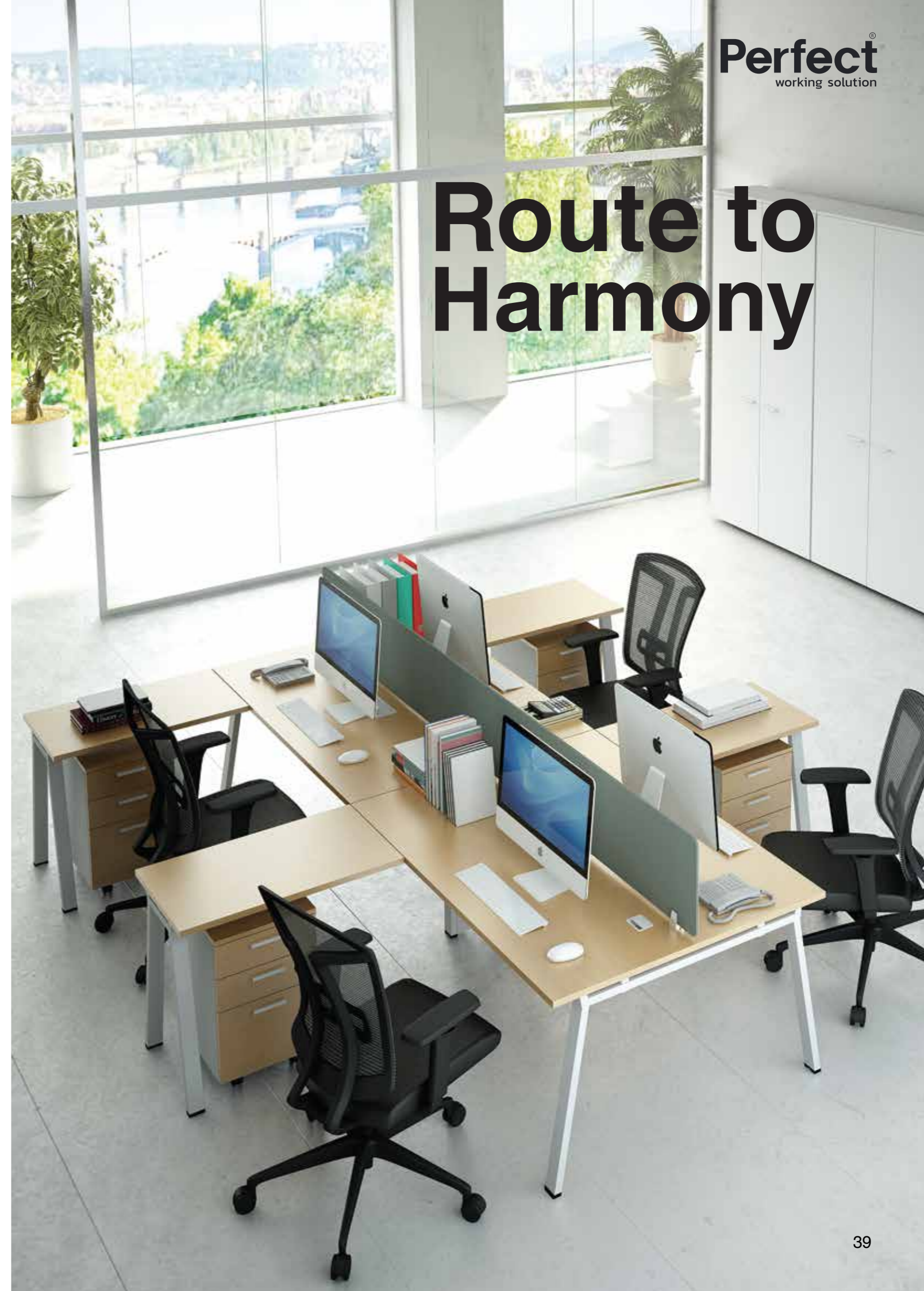

Route

Propinquity

การออกแบบที่คำนึงถึงความกลมกลืนในการใช้งานในทุกรูปแบบ จะช่วยให้ช่องว่างระหว่างผู้บริหารและพนักงานใกล้เคียงมากขึ้น Route ออกแบบมาให้สามารถใช้งานได้ตั้งแต่ห้องผู้บริหารจนถึงระดับพนักงาน

Route

Meet up

พื้นที่ที่ทำงานร่วมกัน ในรูปแบบการทำงานที่ต้องระดมความคิดการผสมผสานการทำงานและพื้นที่ทำงานได้อย่างลงตัว ช่วยเพิ่มศักยภาพในการทำงาน

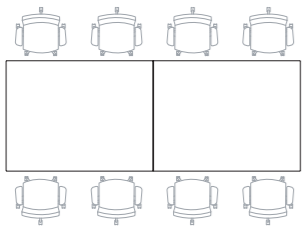

Double team

การทำงานแบบเป็นทีม ที่จะช่วยส่งเสริมความสามารถกันและกัน รูปแบบโต๊ะที่มารองรับการใช้งานพร้อมตู้เอกสารแบบส่วนตัวเพื่อให้เข้าถึงข้อมูลได้ตลอดเวลา จะช่วยส่งเสริมให้ผลงานมีประสิทธิภาพยิ่งขึ้น

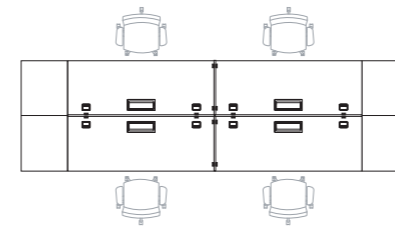

Route to Unique

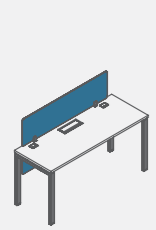

Single desk

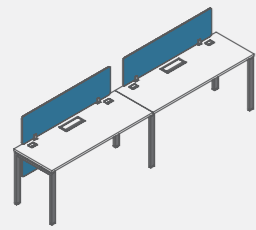

Single bench desks

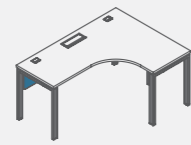

Single desk L-shaped

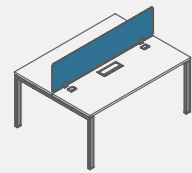

Double desks

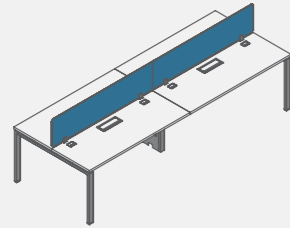

Double bench desks

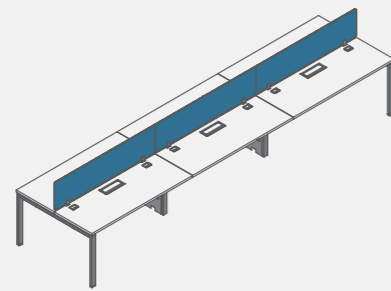

Double bench desks and double connector desks

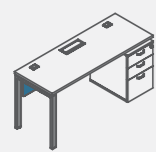

Single desk with support cabinet

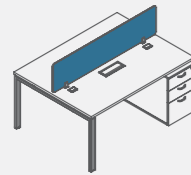

Double desk with support cabinet

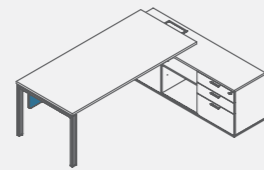

Manager desk with support cabinet

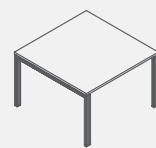

Square meeting table

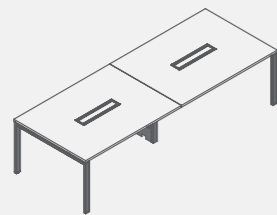

Conference table with top access

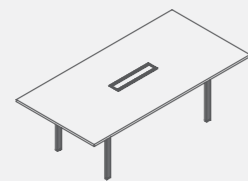

Rectangle meeting table with top access

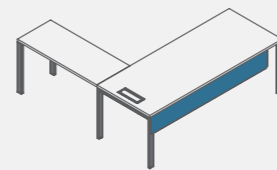

Manager desk with return desk

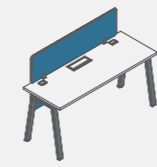

Single desk

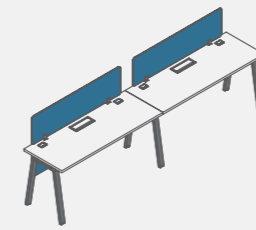

Single bench desks



Single desk L-shaped

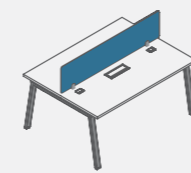

Double desks

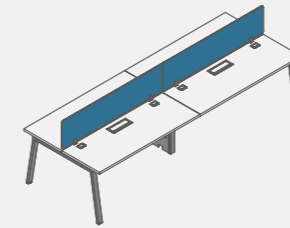

Double bench desks

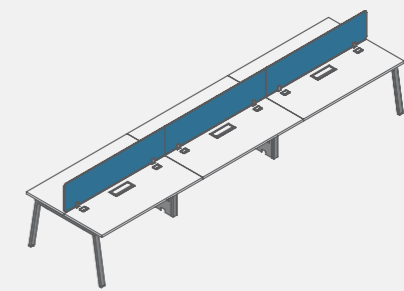

Double bench desks and double connector desks

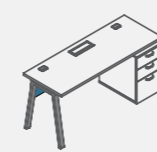

Single desk with support cabinet

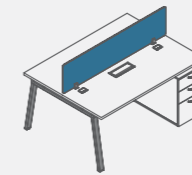

Double desk with support cabinet

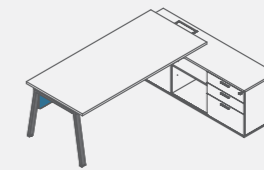

Manager desk with support cabinet

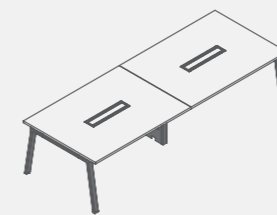

Conference table with top access

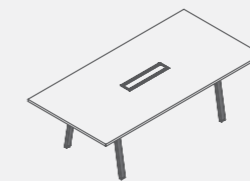

Rectangle meeting table with top access

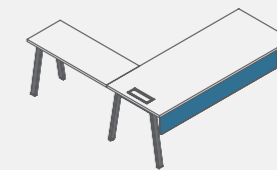

Manager desk with return desk

Route to Harmony

Technical features to Unique & Harmony

คุณสมบัติของท็อปโต๊ะ (Desk top)

ท็อปโต๊ะทำงานแผ่นไม้ปิดผิว มีให้เลือก 2 แบบ คือ ไม้ปาร์ติเกิลบอร์ดปิดผิวเมลามีนและไม้ปาร์ติเกิลบอร์ดปิดผิวไฮเพรสเชอร์ลามิเนต

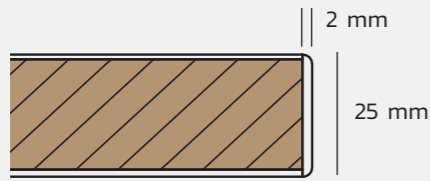

วัสดุ : ปาร์ติเกิลบอร์ด หน้า 25 มม.
การปิดผิว : เมลามีน (MFC)
ปิดขอบ : แถบพลาสติก หน้า 2 มม.

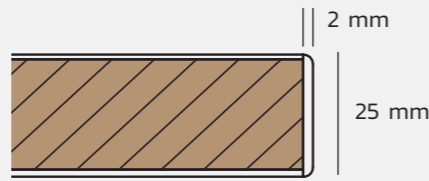

วัสดุ : ปาร์ติเกิลบอร์ด หน้า 25 มม.
การปิดผิว : ไฮเพรสเชอร์ลามิเนต (HPL)
ปิดขอบ : แถบพลาสติก หน้า 2 มม.

โครงสร้างขา (Leg frame)

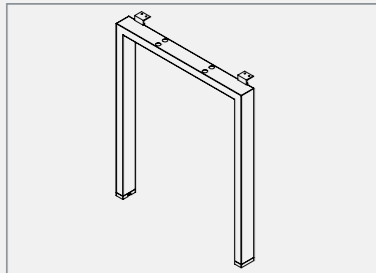

โครงขา U (U Leg) :
เหล็กกล่องหน้าตัดขนาด 60x30 มม.
หน้า 1.2 มม. ตัดเชื่อมเข้ามุม 45 องศา
และทำการพ่นสี Epoxy powder coating

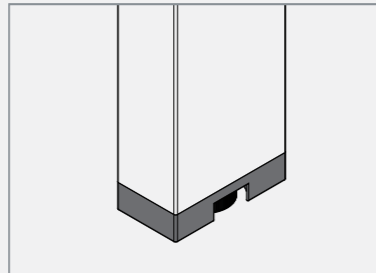

ชุดขาปรับระดับ (Levellor set) :
ขนาดเส้นผ่านศูนย์กลาง 24 มม. เป็น
พลาสติก ABS ฉีดขึ้นรูป ช่วยในการปรับ
ขาโต๊ะให้มีความสมดุลกัน ในกรณีพื้น
ไม่เรียบให้อยู่ในระดับเดียวกัน สามารถ
ปรับได้ไม่เกิน 10 มม.

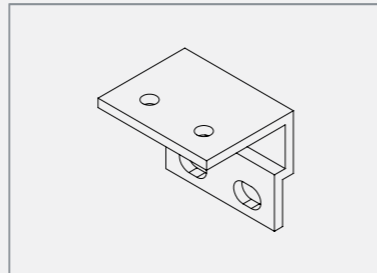

อุปกรณ์ฉากยึดท็อปโต๊ะ (Top support) :
อุปกรณ์ฉากยึดจะถูกติดตั้งเข้ากับขาโต๊ะ
เพื่อยึดชุดโครงขา เข้ากับแผ่นท็อปโต๊ะเป็น
อลูมิเนียมรีดขึ้นรูปพ่นสี Epoxy powder
coating

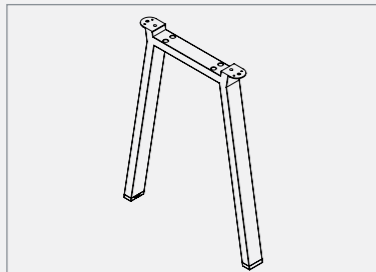

โครงขา H (H Leg) :
เหล็กกล่องหน้าตัดขนาด 60x30 มม.
หน้า 1.2 มม. ตัดเชื่อม และทำการพ่นสี
Epoxy powder coating

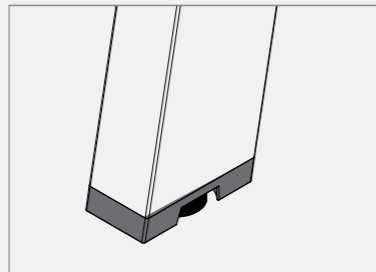

ชุดขาปรับระดับ (Levellor set) :
ขนาดเส้นผ่านศูนย์กลาง 24 มม. เป็น
พลาสติก ABS ฉีดขึ้นรูป ช่วยในการปรับ
ขาโต๊ะให้มีความสมดุลกัน ในกรณีพื้น
ไม่เรียบให้อยู่ในระดับเดียวกัน สามารถ
ปรับได้ไม่เกิน 10 มม.

ชุดคาน (Beam set)

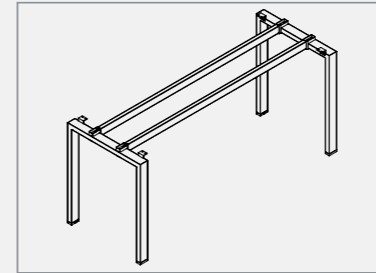

โครงสร้างโต๊ะ (Desk structure) :
โต๊ะเป็นระบบคานคู่ ช่วยให้โต๊ะสามารถ
รับน้ำหนักได้มากและมีความแข็งแรงสูง
โครงสร้างทั้งหมดเป็นโลหะ ทำการพ่นสี
Epoxy powder coating

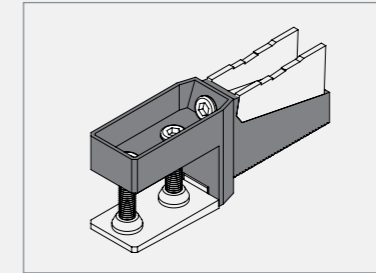

ชุดอุปกรณ์ยึดจับคานเข้ากับโครงขา (Beam clamp) :
อุปกรณ์สำหรับจับยึดคานเข้ากับขาโต๊ะ
ผลิตด้วยกระบวนการฉีดอลูมิเนียมไดแคสตีง
พ่นสี Epoxy powder coating

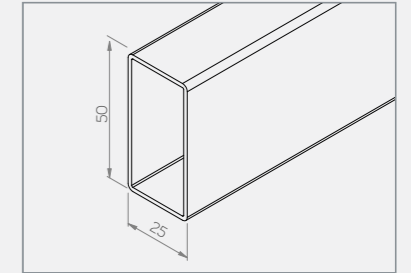

ท่อนคาน (Beam tube) :
เหล็กกล่องหน้าตัดขนาด 50x25 มม.
หน้า 1.2 มม. พ่นสี Epoxy powder coating

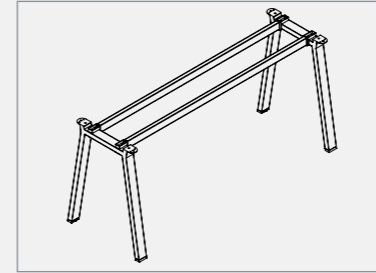

โครงสร้างโต๊ะ (Desk structure) :
โต๊ะเป็นระบบคานคู่ ช่วยให้โต๊ะสามารถ
รับน้ำหนักได้มากและมีความแข็งแรงสูง
โครงสร้างทั้งหมดเป็นโลหะ ทำการพ่นสี
Epoxy powder coating

การจัดการระบบไฟฟ้าและการเข้าถึงข้อมูล (Cable management)

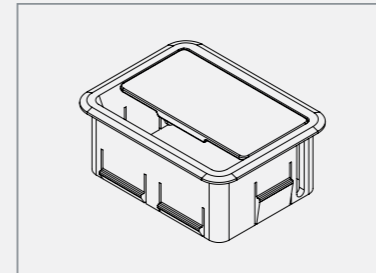

ช่องร้อยสายไฟ (Grommet) :
ช่วยในการจัดการร้อยสายไฟบนท็อปโต๊ะ
วางร้อยสายไฟได้อย่างเป็นระเบียบ เหมาะกับ
การร้อยสายไฟที่ไม่จำเป็นต้องถอดเข้าออก
บ่อยๆ ติดตั้งทางซ้ายและขวา ของท็อปโต๊ะ
ผลิตด้วยพลาสติก ABS ฉีดขึ้นรูป

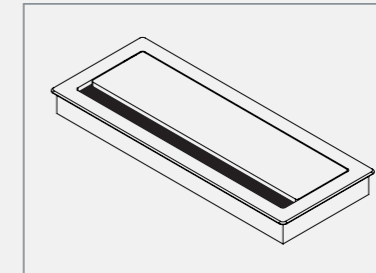

ช่องเสียบปลั๊กไฟจากบนท็อปโต๊ะ (Top access) :
ช่วยให้ผู้ใช้สามารถเสียบปลั๊กไฟได้จาก
ด้านบนของท็อปโต๊ะได้อย่างสะดวก ด้วยช่อง
ขนาด 110 X 290 มม. ผลิตด้วยอลูมิเนียม
และเหล็กพ่นสี Epoxy powder coating

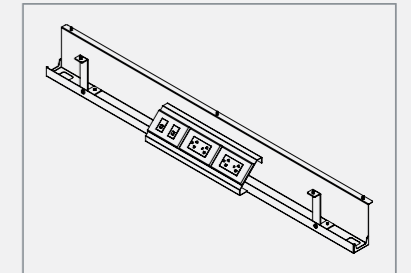

รางร้อยสายไฟและกล่องติดตั้งปลั๊กไฟ (Cable tray & electrical outlet housing) :
ช่วยในการจัดการระบบสายไฟต่างๆ ได้
อย่างเป็นระเบียบ ผลิตจากเหล็กแผ่นหนา
1 มม. พับขึ้นรูป และกล่องติดตั้งปลั๊กไฟ
ใช้เหล็กแผ่นหนา 1.2 มม. พ่นสี Epoxy
powder coating (ไม่รวมอุปกรณ์ไฟฟ้า)

ตู้ใต้โต๊ะ (Support cabinets)

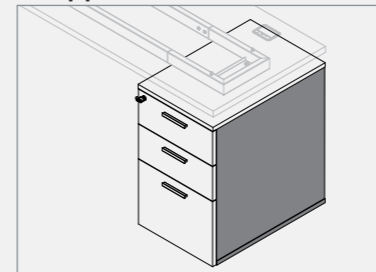

โครงตู้และหน้าบาน (Body & front) :
โครงตู้เป็นไม้ปาร์ติเกิลบอร์ดปิดผิว
เมลามีนความหนา 16 มม. ท็อปตู้เป็นไม้
ปาร์ติเกิลบอร์ดปิดผิวเมลามีนความหนา
25 มม.

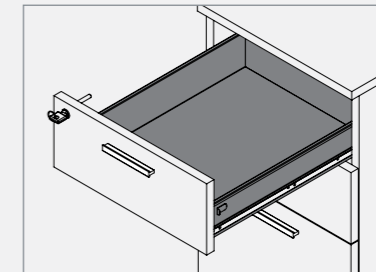

กล่องลิ้นชัก (Drawer box) :
กล่องลิ้นชักมี 2 แบบ คือ กล่องลิ้นชักไม้
ผลิตจากไม้ปาร์ติเกิลบอร์ดปิดผิวเมลามีนสีดำ
ความหนา 12 มม. และกล่องลิ้นชักเหล็ก
ผลิตจากเหล็กแผ่นหนา 0.7 และ 1 มม.
พับขึ้นรูป พ่นสี Epoxy powder coating
สีดำ ติดตั้งกับรางลิ้นชักแบบรางลูกปืน

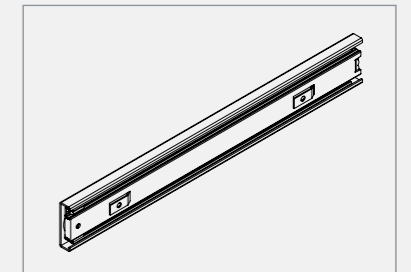

รางลิ้นชัก (Ball bearing drawer slides) :
รางลูกปืน ความยาว 18 นิ้ว
รับน้ำหนักได้สูงสุด 40 กก.



Teamwork

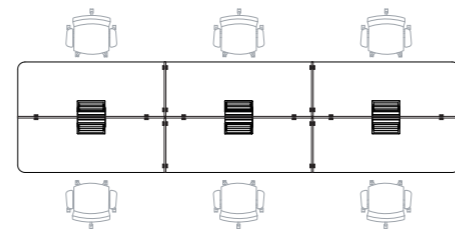

Nature ถูกออกแบบมาเพื่อรองรับการทำงานแบบทีมโดยเฉพาะจากการออกแบบโครงสร้างเพื่อจัดการในส่วนของเขาโต๊ะให้โปร่งโล่ง เพื่อที่จะให้การใช้งานเป็นไปได้อย่างสะดวก และรองรับพฤติกรรมการใช้งานในรูปแบบการทำงานเป็นทีมและสามารถสื่อสารโต้ตอบกันได้ อีกทั้งก็ยังมีความเป็นส่วนตัวในระดับหนึ่งเพื่อใช้ในเวลาที่ต้องการเพิ่มสมาธิในการทำงาน เพราะเราเชื่อว่าพื้นที่สร้างสรรค์มีส่วนสำคัญในการทำงานที่จำเป็นสำหรับการแลกเปลี่ยนประสบการณ์และแบ่งปันการนำเสนองานและข้อมูลการทำงานที่สำคัญ เพื่อให้สามารถบรรลุถึงเป้าหมายเดียวกันได้

Nature

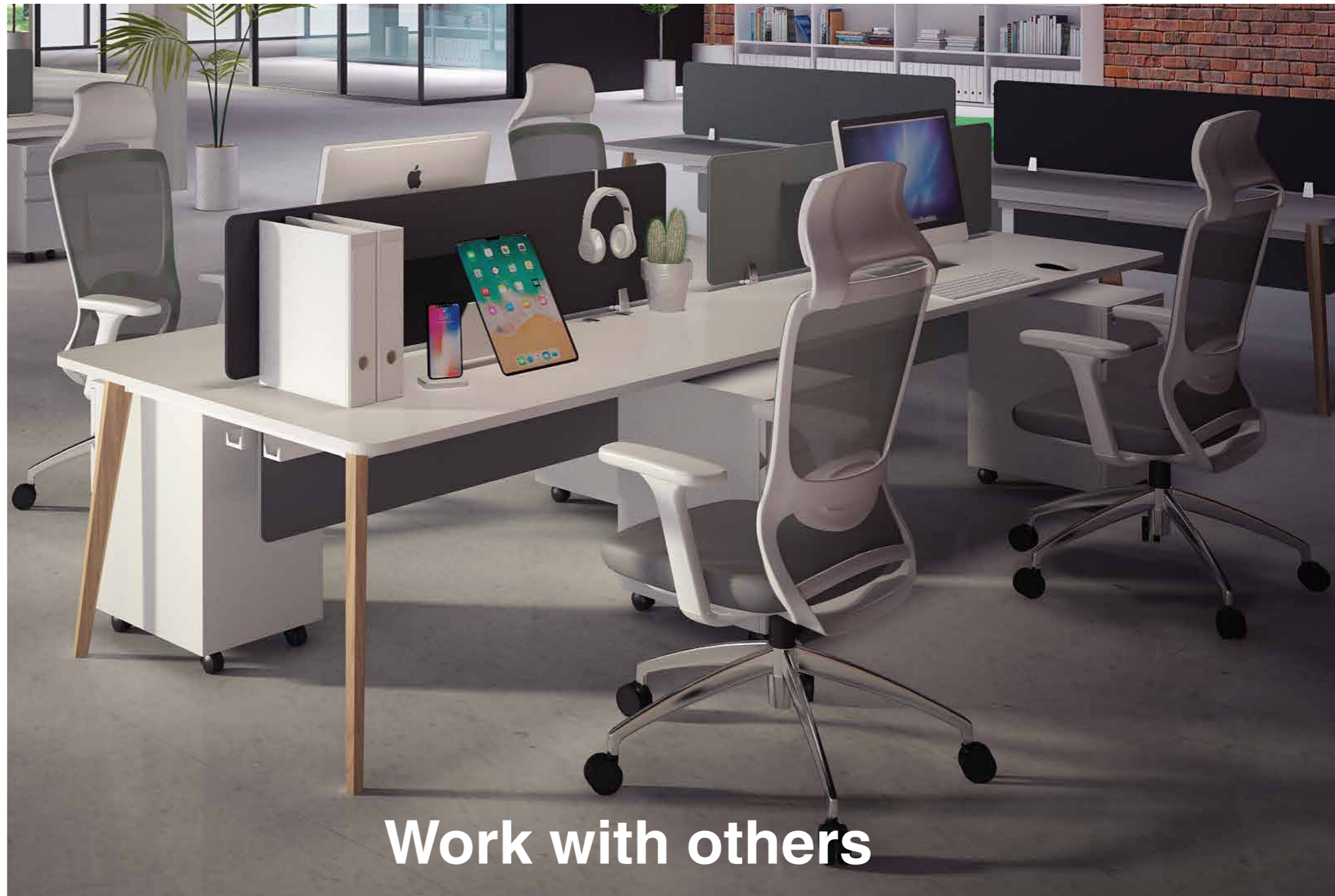

Work with others

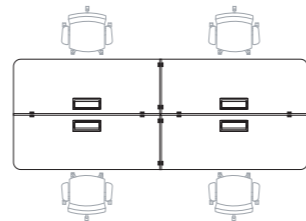

Nature ถูกออกแบบมาให้สามารถรองรับการใช้งานได้หลากหลายประเภท เพื่อให้สามารถปรับใช้ได้ดีกับทุกๆ การใช้งาน จุดเด่นอยู่ที่รูปทรงของขาที่มีการออกแบบให้ใกล้เคียงกับธรรมชาติมากที่สุด

Nature



Systematic

รูปแบบของโต๊ะที่หลากหลาย รวมไปถึงส่วนเสริมที่มีให้เลือกมากมาย ทำให้ Nature เป็นโต๊ะทำงานที่รองรับการใช้งานได้ครอบคลุมทุกๆ พฤติกรรมการใช้งาน

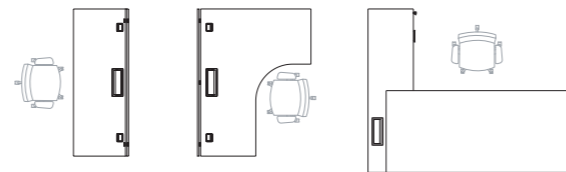

To be executive

โต๊ะผู้บริหารที่เสริมตู้ยาวแทนขาด้านล่าง ที่จะเข้ามาช่วยให้โต๊ะทำงานของคุณมีการใช้งานให้มีประสิทธิภาพมากขึ้น และยังช่วยสร้างภาพลักษณ์ที่ดี ดูมั่นคง ภูมิฐาน และสง่างามแก่ผู้ใช้งาน



Success meeting

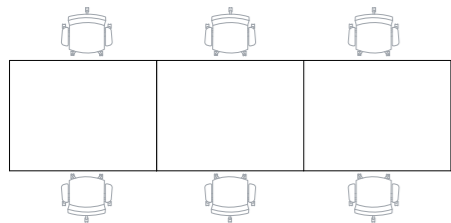

ความสำเร็จของการประชุมทุกครั้งขึ้นอยู่กับ การสื่อสารที่ดี การแก้ปัญหา หรือการระดมความคิดต่างๆ บรรยากาศในห้องประชุมก็มีส่วนสำคัญที่จะนำไปสู่ความสำเร็จ Nature ถูกออกแบบมาให้ช่วยทำให้บรรยากาศในที่ประชุมของคุณนั้นผ่อนคลายมากขึ้น เพื่อช่วยเพิ่มประสิทธิภาพของการแลกเปลี่ยนความคิดและการสนทนาอย่างอิสระระหว่างผู้เข้าร่วมประชุมทั้งหมด

Nature

You and I

การทำงานแบบที่มีคู่หูที่รู้ใจ ก็จะช่วยให้มีประสิทธิภาพมากขึ้น และจะยิ่งได้ผลมากขึ้น ถ้ามีพื้นที่การใช้งานในการสร้างสรรค์เพิ่มเติม และมีพื้นที่เก็บของส่วนตัว ทำให้สามารถจัดการงานต่างๆ ได้ภายในโต๊ะทำงานของตนเองได้อย่างลงตัว

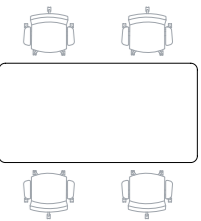



การเพิ่มพื้นที่การทำงานเพื่อรองรับการใช้งานที่หลากหลาย ให้สามารถใช้พื้นที่ให้เป็นประโยชน์มากที่สุด ก็เป็นอีกจุดประสงค์หลักของการออกแบบซีรีส์ Nature โดยสามารถใช้เป็นพื้นที่ส่วนเพิ่มเติมขึ้นมาจากแต่ละคน หรือจะเพิ่มพื้นที่ตรงกลางระหว่างสองโต๊ะเพื่อกำหนดให้เป็นพื้นที่ใช้งานร่วมกันก็เป็นได้

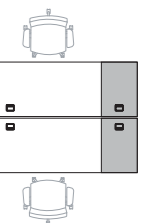
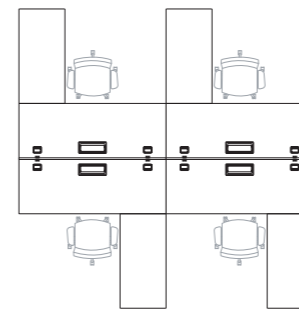

Nature



Meeting

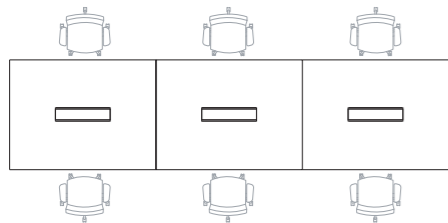

Nature ถูกออกแบบให้สามารถรองรับการใช้งานในการประชุมได้เต็มประสิทธิภาพ ทั้งรูปแบบโต๊ะที่สามารถขยายเพื่อรองรับการใช้งานตามที่คุณต้องการ พร้อมกับ การเดินสายไฟที่สามารถเดินได้ตลอดแนวโต๊ะเพื่อเป็นการการันตีว่า ทุกคนที่ใช้งาน จะสามารถเข้าถึงการใช้งานทุกอย่างได้อย่างสะดวก

Nature

ROUND TOP DESKS

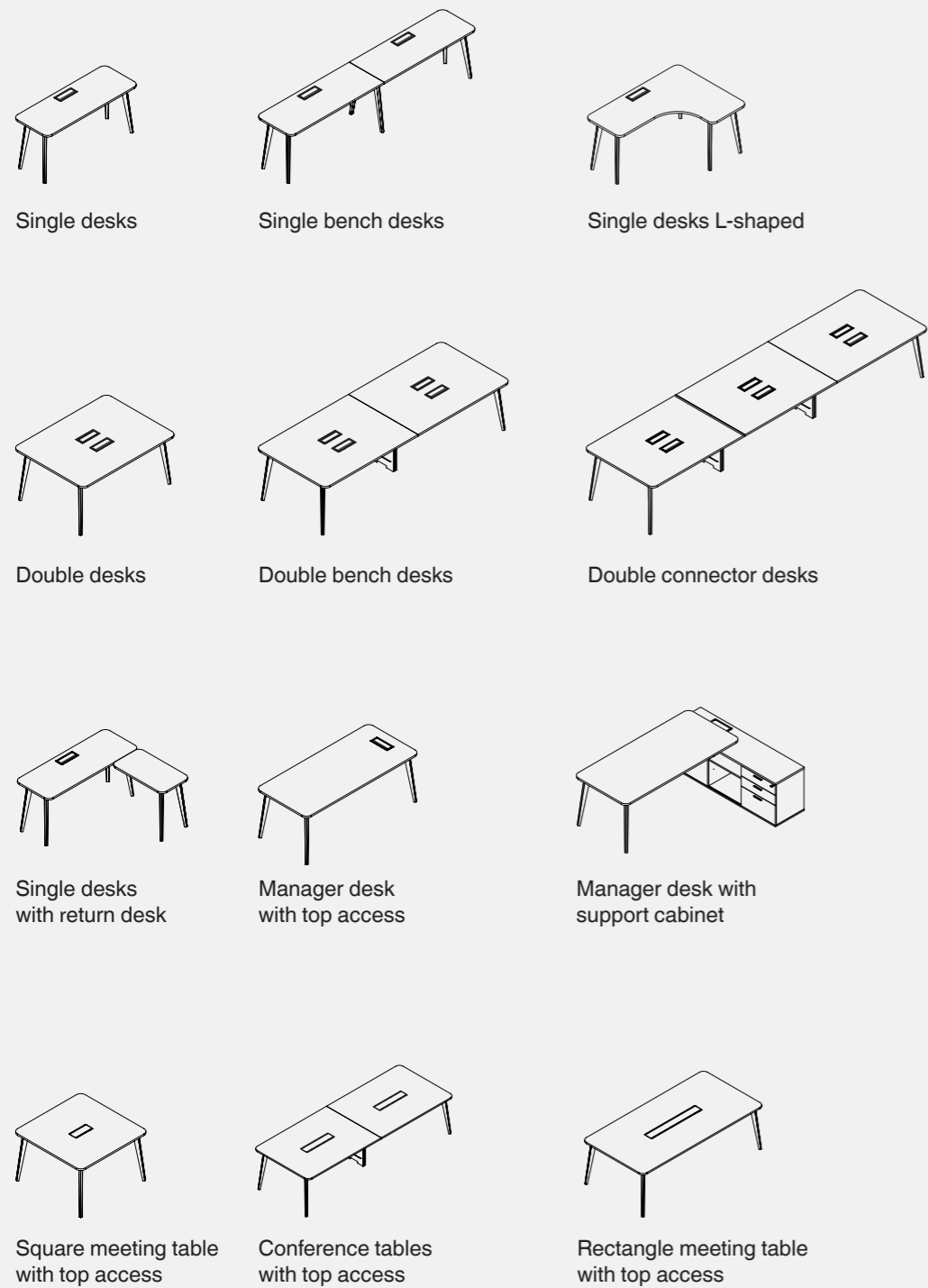

STRAIGHT TOP DESKS

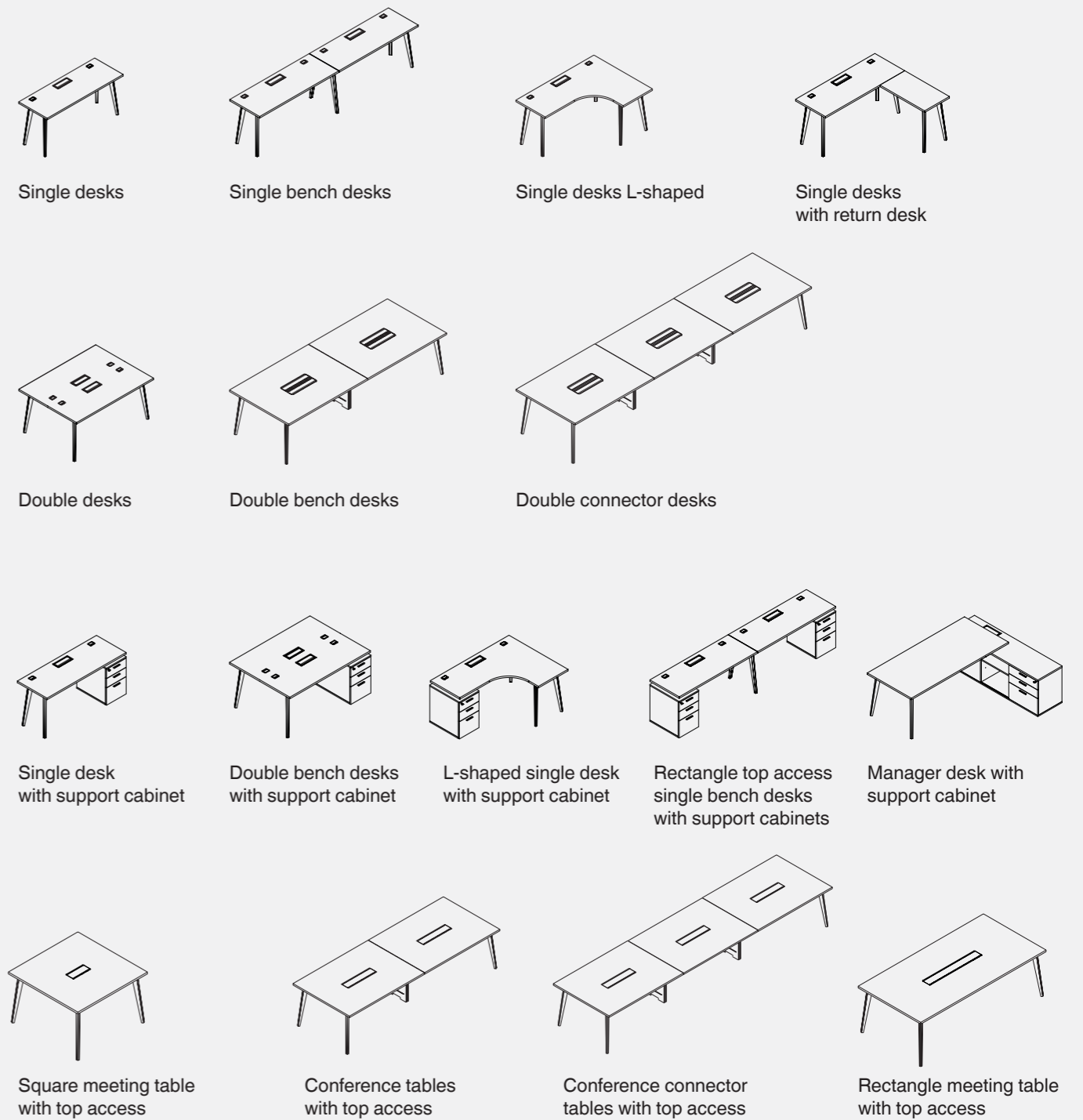

Technical features Nature

คุณสมบัติของท็อปโต๊ะ (Desk top)

ท็อปโต๊ะทำจากแผ่นไม้ปิดผิว มีให้เลือก 2 แบบ คือ ไม้ปาร์ติเกิลบอร์ดปิดผิวเมลามีนและไม้ปาร์ติเกิลบอร์ดปิดผิวไฮเพรสเซอร์ลามิเนต

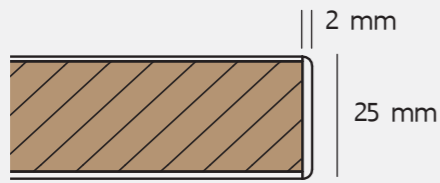

วัสดุ : ปาร์ติเกิลบอร์ดหนา 25 มม.
การปิดผิว : เมลามีน (MFC)
ปิดขอบ : แถบพลาสติกหนา 2 มม.

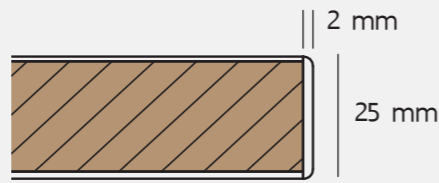

วัสดุ : ปาร์ติเกิลบอร์ดหนา 25 มม.
การปิดผิว : ไฮเพรสเซอร์ลามิเนต (HPL)
ปิดขอบ : แถบพลาสติกหนา 2 มม.

โครงสร้างขา (Leg frame)

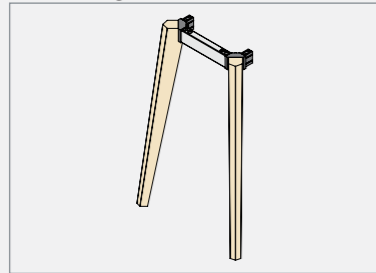

ขา (Leg frame) : เหล็กแผ่นหนา 2 มม. พับขึ้นรูป ตัดเชื่อม ประกอบ และทำการ Water transfer printing ด้วยฟิล์มลายไม้

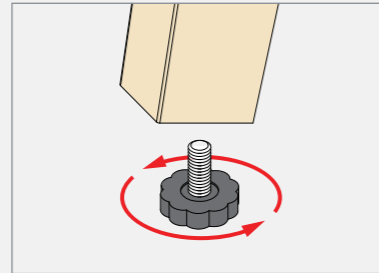

ชุดขาปรับระดับ (Levellor set) : ขนาดเส้นผ่านศูนย์กลาง 24 มม. เป็นพลาสติก ABS ฉีดขึ้นรูป ช่วยในการปรับขาโต๊ะให้มีความสมดุลกัน ในกรณีที่พื้นไม่เรียบหรืออยู่ในระดับเดียวกัน สามารถปรับได้ไม่เกิน 10 มม.

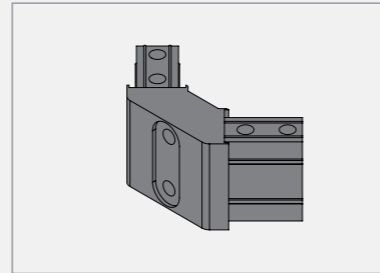

ข้อต่อขา (Corner joint) : ข้อต่อขา ผลิตด้วยกระบวนการฉีดอลูมิเนียมไดแคสติง (Aluminium die-casting) และทำการพ่นสี Epoxy powder coating สีเทา

ชุดคาน (Beam set)

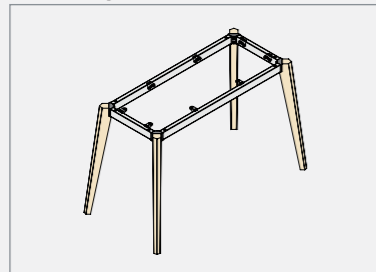

โครงสร้างโต๊ะ (Desk structure) : โต๊ะเป็นระบบคานรอบ ช่วยให้โต๊ะสามารถรับน้ำหนักได้มากและมีความแข็งแรงสูงโครงสร้างทั้งหมดเป็นโลหะ ทำการพ่นสี Epoxy powder coating

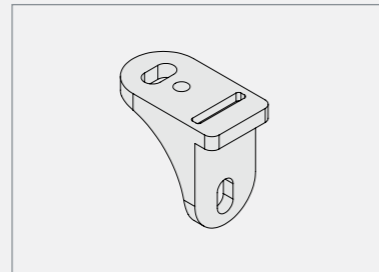

ชุดอุปกรณ์ยึดจับคานเข้ากับท็อปโต๊ะ (Top support) : อุปกรณ์สำหรับยึดคานเข้ากับท็อปโต๊ะผลิตจากพลาสติก ABS ฉีดขึ้นรูป

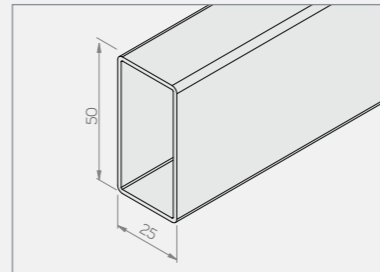

ท่อนคาน (Beam tube) : เหล็กกล่องหน้าตัดขนาด 50x25 มม. หนา 1.2 มม. พ่นสี Epoxy powder coating

ฉากกั้น (Privacy screen) & แผ่นบังตา (Modesty)

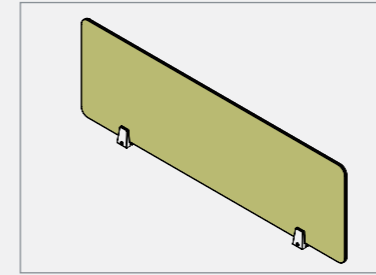

ฉากกั้นหุ้มผ้า (Fabric screen) : ไม้ปาร์ติเกิลบอร์ดหนา 8 มม. เซาะร่องไม้รอบด้าน หรือปาร์ติเกิลบอร์ดหนา 16 มม. หุ้มด้วยผ้า ติดตั้งด้วยตัวจับยึดฉากกั้น

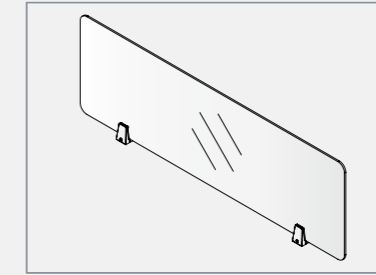

ฉากกั้นกระจก (Glass screen) : -กระจกใสเป็นกระจกธรรมดาเยอรมัน (Float glass) หนา 6 มม.
-กระจกฝ้าเป็นกระจกธรรมดาเยอรมัน หนา 6 มม. ทำฝ้าโดยการพ่นทราย (Sandblasting)

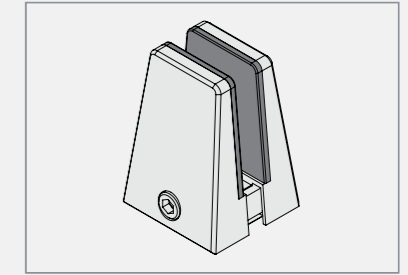

ตัวจับยึดฉากกั้น (Clamp for screen) : ผลิตด้วยกระบวนการฉีดอลูมิเนียมไดแคสติงพ่นสี Epoxy powder coating สามารถใช้ติดตั้งร่วมกับฉากกั้นไม้หุ้มผ้าและกระจกได้

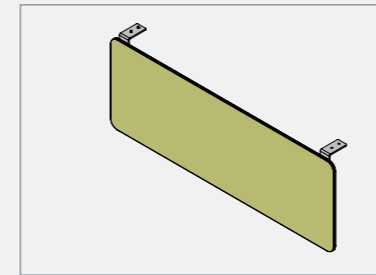

แผ่นบังตาหุ้มผ้า (Fabric modesty panel) : ปาร์ติเกิลบอร์ดหนา 16 มม. เซาะร่องไม้รอบด้าน หุ้มด้วยผ้า ติดตั้งด้วยชุดอุปกรณ์จับยึดแผ่นบังตา

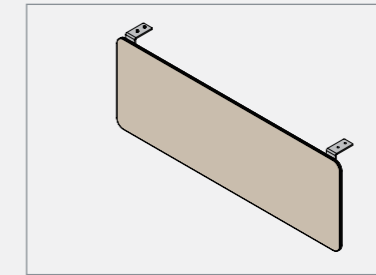

แผ่นบังตาไม้ (Wooden modesty panel) : ปาร์ติเกิลบอร์ดหนา 16 มม. ปิดผิวด้วยเมลามีนหรือไฮเพรสเซอร์ลามิเนต ปิดขอบด้วยแถบพลาสติกหนา 1 มม. รอบด้าน ติดตั้งด้วยชุดอุปกรณ์จับยึดแผ่นบังตา

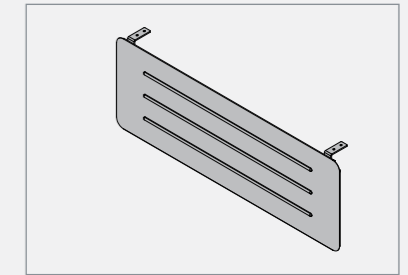

แผ่นบังตาเหล็ก (Steel modesty panel) : แผ่นเหล็กหนา 1.2 มม. พับขึ้นรูป พ่นสี Epoxy powder coating ติดตั้งด้วยชุดอุปกรณ์จับยึดแผ่นบังตา

การจัดการระบบไฟฟ้าและการเข้าถึงข้อมูล (Cable management)

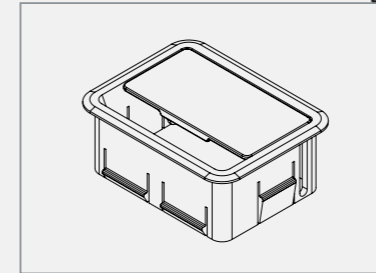

ช่องร้อยสายไฟ (Grommet) : ช่วยในการจัดการร้อยสายไฟบนท็อปโต๊ะ ลงสู่รางร้อยสายไฟได้อย่างเป็นระเบียบ เหมาะกับการร้อยสายไฟที่ไม่จำเป็นต้องถอดเข้าออกบ่อยๆ ติดตั้งทางซ้ายและขวาของท็อปโต๊ะ ผลิตด้วยพลาสติก ABS ฉีดขึ้นรูป

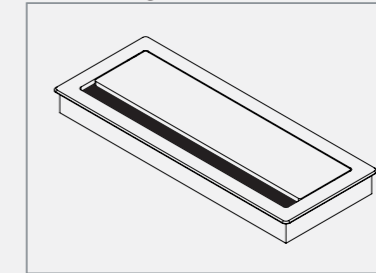

ช่องเสียบปลั๊กไฟจากบนท็อปโต๊ะ (Top access) : ช่วยให้ผู้ใช้สามารถเสียบปลั๊กไฟจากด้านบนของท็อปโต๊ะได้อย่างสะดวก ด้วยช่องขนาด 110 X 290 มม. ผลิตด้วยอลูมิเนียมและเหล็กพ่นสี Epoxy powder coating

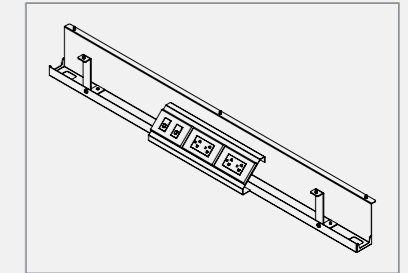

รางร้อยสายไฟและกล่องติดตั้งปลั๊กไฟ (Cable tray & electrical outlet housing) : ช่วยในการจัดการระบบสายไฟต่างๆ ได้อย่างเป็นระเบียบ ผลิตจากเหล็กแผ่นหนา 1 มม. พับขึ้นรูป และกล่องติดตั้งปลั๊กไฟใช้เหล็กแผ่นหนา 1.2 มม. พ่นสี Epoxy powder coating (ไม่รวมอุปกรณ์ไฟฟ้า)

ตู้ใต้โต๊ะ (Support cabinets)

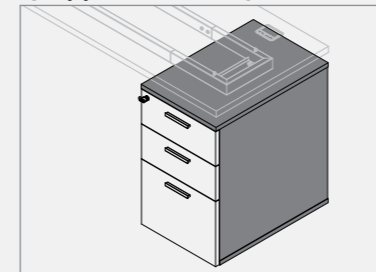

โครงตู้และหน้าบาน (Body & front) : โครงตู้เป็นไม้ปาร์ติเกิลบอร์ดปิดผิวเมลามีนความหนา 16 มม. ท็อปตู้เป็นไม้ปาร์ติเกิลบอร์ดปิดผิวเมลามีนความหนา 25 มม.

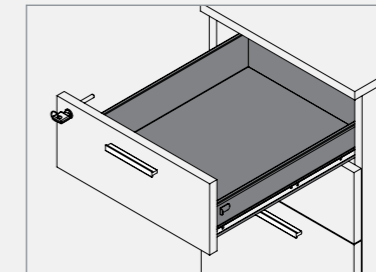

กล่องลิ้นชัก (Drawer box) : กล่องลิ้นชักมี 2 แบบ คือ กล่องลิ้นชักไม้ ผลิตจากไม้ปาร์ติเกิลบอร์ดปิดผิวเมลามีนสีดำ ความหนา 12 มม. และกล่องลิ้นชักเหล็ก ผลิตจากเหล็กแผ่นหนา 0.7 และ 1 มม. พับขึ้นรูป พ่นสี Epoxy powder coating สีดำ ติดตั้งกับรางลิ้นชักแบบรางลูกปืน

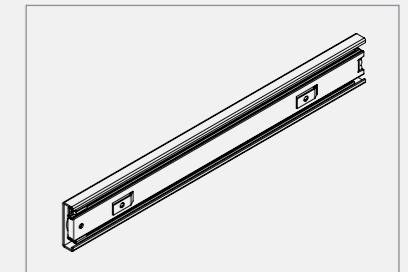

รางลิ้นชัก (Ball bearing drawer slides) : รางลูกปืน ความยาว 18 นิ้ว รับน้ำหนักได้สูงสุด 40 กก.

A-SYSTEM

Introduction

An innovative concept for great demands
TWO TONE is an optically appealing modular table base system with many advantages.

- The ergonomic requirements that occur in different working situations are met extremely well.
- Different system combinations meet many different requirements.
- Well-thought-out design makes assembly quick and easy, even for the inexperienced.
- All the table components are supplied in boxes, providing protection while saving space.

Modular table system

Table legs, frames and frame joints are assembled into individual tables or table combinations.

Accessories

A wide range of accessories allows all components a reliable integration to match the overall design.



Structure Systems

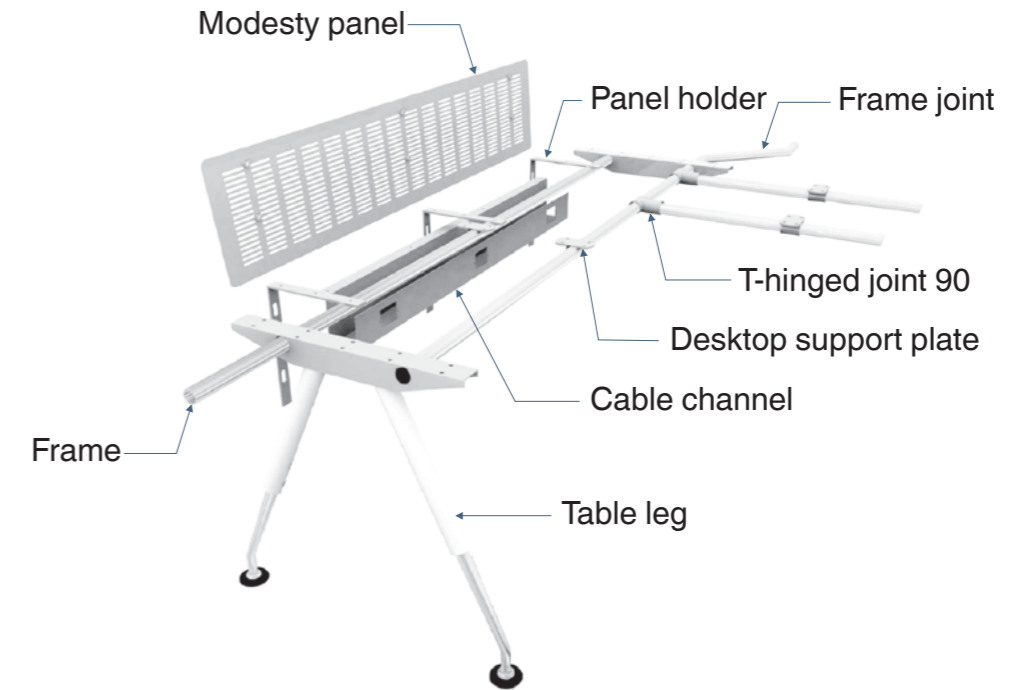

TABLE LEG

FOR SUPPORT WORK TOP



A2



A2.1

FOR SUPPORT EXTENSION TOP



A2.2



A2.3



A2.4

Specification

Material	Steel
Finish	Epoxy powder coated, silver BFF/8551/C, white FF110/08/C; OXYPLAST, chrome plated
Version	With table top support for supporting the table top, with tube cap for protruding frames
Height adjustment	740-760 mm. with adjusting screws [for panel thickness 28 mm.]
For left and right hand use	

A-SYSTEM

Integrated



	EXECUTIVE DESK	EXECUTIVE CABINET
A	2800,2600,2500	2700
B	2000,1800,1700,1600	420

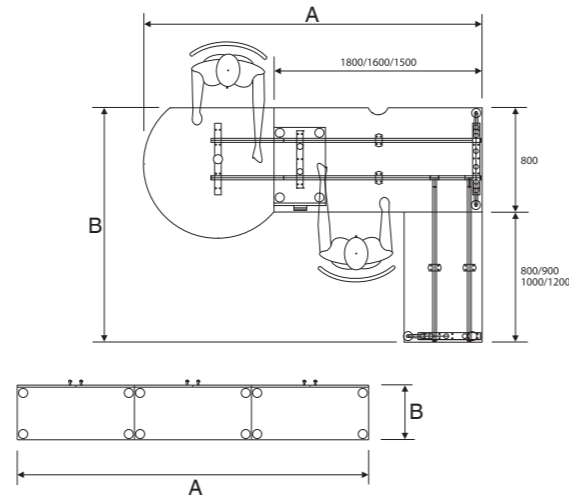

STAFF WORKING CLUSTER 4 PERSONS		PRIVACY SCREEN	
A	2430	W	1200
B	2430	H	760



STAFF WORKING CLUSTER 4 PERSONS		PRIVACY SCREEN	
A	3200	W	1200,800
B	2430	H	380

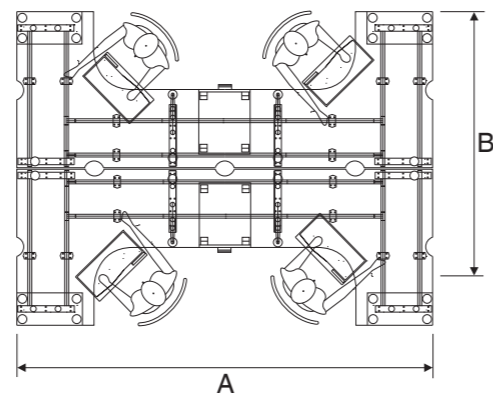

Mobile & Cabinet / Special

MOBILE & STORAGE CABINET



MOBILE PEDESTAL [3D]
VACUUM DRAWER
1 PENCIL DRAWER
1 SMALL DRAWER
1 HANGING FILE DRAWER

CODE : 673 PCMB/WS
DIM : W395 x D500 x H670



STAND PEDESTAL [3D]
VACUUM DRAWER
1 PENCIL DRAWER
1 SMALL DRAWER
1 HANGING FILE DRAWER

CODE : 753 PCMB/WS
DIM : W395 x D600 x H750



MOBILE PEDESTAL [3D]
VACUUM DRAWER
1 PENCIL DRAWER
1 HANGING FILE DRAWER

CODE : 752 ATMB/WS
DIM : W395 x D600 x H720



CREDENZA
VACUUM DRAWER
1 DOOR
1 SMALL DRAWER
1 HANGING FILE DRAWER

CODE : 120 ATMB/WS
DIM : W1200 x D530 x H630



2-DOOR CABINET
1 ADJUSTABLE SHELF

CODE : ATSM 829 O
DIM : W900 x D420 x H820



2-DOOR CABINET
2 ADJUSTABLE SHELVES

CODE : ATSM 129 O
DIM : W900 x D420 x H1200



4-DOOR CABINET
1 SHELF
2 ADJUSTABLE SHELVES

CODE : ATSM 169 W
DIM : W900 x D420 x H1600



4-DOOR CABINET
WARDROBE STORAGE
3 SHELVES
1 ADJUSTABLE SHELF

CODE : ATSM 169 O
DIM : W900 x D420 x H1600

ACCESSORIES



CPU HOLDER

CODE : AC-HS CPU
DIM : W12-20 x D15.7 x H35.7-55.7



CPU HOLDER

CODE : AC-HB CPU
DIM : W22.8 x D48 x H48



MOBILE CPU HOLDER

CODE : AC-MB CPU
DIM : W22.8 x D48 x H54.7

BRAVO



BRSD 800-60
W.80 x H.75 x D.60 cm
BRSD 1000-60
W.100 x H.75 x D.60 cm
BRSD 1200-60
W.120 x H.75 x D.60 cm
BRSD 1500-60
W.150 x H.75 x D.60 cm
BRSD 1600-60
W.160 x H.75 x D.60 cm
BRSD 1800-60
W.180 x H.75 x D.60 cm



BRSD 800-80
W.80 x H.75 x D.80 cm
BRSD 1000-80
W.100 x H.75 x D.80 cm
BRSD 1200-80
W.120 x H.75 x D.80 cm
BRSD 1500-80
W.150 x H.75 x D.80 cm
BRSD 1600-80
W.160 x H.75 x D.80 cm
BRSD 1800-80
W.180 x H.75 x D.80 cm



BRSS 800-68
W.80 x H.75 x D.60 x D.80 cm
BRSS 1000-68
W.100 x H.75 x D.60 x D.80 cm
BRSS 1200-68
W.120 x H.75 x D.60 x D.80 cm
BRSS 1500-68
W.150 x H.75 x D.60 x D.80 cm
BRSS 1600-68
W.160 x H.75 x D.60 x D.80 cm
BRSS 1800-68
W.180 x H.75 x D.60 x D.80 cm



BRSS 800-86
W.80 x H.75 x D.80 x D.60 cm
BRSS 1000-86
W.100 x H.75 x D.80 x D.60 cm
BRSS 1200-86
W.120 x H.75 x D.80 x D.60 cm
BRSS 1500-86
W.150 x H.75 x D.80 x D.60 cm
BRSS 1600-86
W.160 x H.75 x D.80 x D.60 cm
BRSS 1800-86
W.180 x H.75 x D.80 x D.60 cm



BRLS 1512-66 L
W.150 x H.75 x D.120 x D.60 x D.60 cm
BRLS 1612-66 L
W.160 x H.75 x D.120 x D.60 x D.60 cm
BRLS 1812-66 L
W.180 x H.75 x D.120 x D.60 x D.60 cm
BRLS 1512-66 R
W.150 x H.75 x D.120 x D.60 x D.60 cm
BRLS 1612-66 R
W.160 x H.75 x D.120 x D.60 x D.60 cm
BRLS 1812-66 R
W.180 x H.75 x D.120 x D.60 x D.60 cm



BRLS 1618-86 L
W.160 x H.75 x D.180 x D.80 x D.60 cm
BRLS 1618-86 R
W.160 x H.75 x D.180 x D.80 x D.60 cm
BRLS 1818-86 L
W.180 x H.75 x D.180 x D.80 x D.60 cm
BRLS 1818-86 R
W.180 x H.75 x D.180 x D.80 x D.60 cm

BRAVO



BRSL 1512-86 L
W.150 x H.75 x D.120 x D.80 x D.60 cm
BRSL 1512-86 R
W.150 x H.75 x D.120 x D.80 x D.60 cm
BRSL 1612-86 L
W.160 x H.75 x D.120 x D.80 x D.60 cm
BRSL 1612-86 R
W.160 x H.75 x D.120 x D.80 x D.60 cm
BRSL 1812-86 L
W.180 x H.75 x D.120 x D.80 x D.60 cm
BRSL 1812-86 R
W.180 x H.75 x D.120 x D.80 x D.60 cm



BRCN 1010-66
W.100 x H.75 x D.100 x D.60 x D.60 cm
BRCN 1212-66
W.120 x H.75 x D.120 x D.60 x D.60 cm



BRCN 1010-68
W.100 x H.75 x D.100 x D.60 x D.80 cm
BRCN 1212-68
W.120 x H.75 x D.120 x D.60 x D.80 cm
BRCN 1010-86
W.100 x H.75 x D.100 x D.80 x D.60 cm
BRCN 1212-86
W.120 x H.75 x D.120 x D.80 x D.60 cm



BRCN 1010-88
W.100 x H.75 x D.100 x D.80 x D.80 cm
BRCN 1212-88
W.120 x H.75 x D.120 x D.80 x D.80 cm



BRVS 1212-66
W.120 x H.75 x D.120 x D.60 x D.60 cm



BRCD 800-60S
W.80 x H.75 x D.60 cm



BRCD 1200-60S+KB 02
W.120 x H.75 x D.60 cm
BRCD 1500-80S+KB 02
W.150 x H.75 x D.80 cm



BRCD 800-60+KB 02
W.80 x H.75 x D.60 cm



BRRD 1000-486L
W.100 x H.75 x D.48 cm
BRRD 1000-486R
W.100 x H.75 x D.48 cm
BRRD 1000-488L
W.100 x H.75 x D.48 cm
BRRD 1000-488R
W.100 x H.75 x D.48 cm



BRRD 1000-486 OL
W.100 x H.75 x D.48 cm
BRRD 1000-486 OR
W.100 x H.75 x D.48 cm
BRRD 1000-488 OL
W.100 x H.75 x D.48 cm
BRRD 1000-488 OR
W.100 x H.75 x D.48 cm



BREX 6060-1Q
W.65 x H.2.8 x D.65 cm
BREX 8080-1Q
W.85 x H.2.8 x D.85 cm



BREX 6080-1Q
W.65 x H.2.8 x D.85 cm
BREX 8060-1Q
W.85 x H.2.8 x D.65 cm



BREX 8080-2Q
W.80 x H.2.8 x D.80 cm



BREX 1245-2Q
W.120 x H.2.8 x D.45 cm
BREX 1645-2Q
W.160 x H.2.8 x D.45 cm



BREX 1260-2Q
W.120 x H.2.8 x D.60 cm
BREX 1680-2Q
W.160 x H.2.8 x D.80 cm



BREX 1280-3QL
W.120 x H.2.8 x D.80 cm
BREX 1280-3QR
W.120 x H.2.8 x D.80 cm



BREX 1248-3Q
W.120 x H.2.8 x D.40 x D.80 cm
BREX 1284-3Q
W.120 x H.2.8 x D.80 x D.40 cm



BREX 1266-3Q
W.120 x H.2.8 x D.60 x D.60 cm
BREX 1288-3Q
W.120 x H.2.8 x D.80 x D.80 cm



BRMT 1000R
R.100 x H.75 cm
BRMT 1200R
R.120 x H.75 cm



BRMT 1800-90B
W.180 x H.75 x D.90 cm
BRMT 2400-11B
W.240 x H.75 x D.110 cm



BRMT 3600-12B
W.360 x H.75 x D.120 cm



ACSL001
W.10 x H.72 cm



ACSL002
W.50 x H.72 x D.15 cm



ACSL003
W.5 x H.72 cm

DYNAMIC



DNM-SD1890-WC
W.180 x H.75 x D.90 cm
DNM-SD2090-WC
W.200 x H.75 x D.90 cm



DNM-RT0945-W25
W.90 x H.75 x D.45 cm
DNM-RT1045-W25
W.100 x H.75 x D.45 cm
DNM-RT1245-W25
W.120 x H.75 x D.45 cm



DNM-SD1260-00
W.120 x H.75 x D.60 cm
DNM-SD1460-00
W.140 x H.75 x D.60 cm
DNM-SD1560-00
W.150 x H.75 x D.60 cm
DNM-SD1660-00
W.160 x H.75 x D.60 cm
DNM-SD1860-00
W.180 x H.75 x D.60 cm



DNM-SD1260-30M
W.120 x H.75 x D.60 cm
DNM-SD1460-30M
W.140 x H.75 x D.60 cm
DNM-SD1560-30M
W.150 x H.75 x D.60 cm
DNM-SD1660-30M
W.160 x H.75 x D.60 cm
DNM-SD1860-30M
W.180 x H.75 x D.60 cm



DNM-SD1280-30
W.120 x H.75 x D.80 cm
DNM-SD1480-30
W.140 x H.75 x D.80 cm
DNM-SD1580-30
W.150 x H.75 x D.80 cm
DNM-SD1680-30
W.160 x H.75 x D.80 cm
DNM-SD1880-30
W.180 x H.75 x D.80 cm



DNM-SD1280-30M
W.120 x H.75 x D.80 cm
DNM-SD1480-30M
W.140 x H.75 x D.80 cm
DNM-SD1580-30M
W.150 x H.75 x D.80 cm
DNM-SD1680-30M
W.160 x H.75 x D.80 cm
DNM-SD1880-30M
W.180 x H.75 x D.80 cm



DNM-SD1260-00M
W.120 x H.75 x D.60 cm
DNM-SD1460-00M
W.140 x H.75 x D.60 cm
DNM-SD1560-00M
W.150 x H.75 x D.60 cm
DNM-SD1660-00M
W.160 x H.75 x D.60 cm
DNM-SD1860-00M
W.180 x H.75 x D.60 cm



DNM-SD1280-00
W.120 x H.75 x D.80 cm
DNM-SD1480-00
W.140 x H.75 x D.80 cm
DNM-SD1580-00
W.150 x H.75 x D.80 cm
DNM-SD1680-00
W.160 x H.75 x D.80 cm
DNM-SD1880-00
W.180 x H.75 x D.80 cm



DNM-SD1280-00M
W.120 x H.75 x D.80 cm
DNM-SD1480-00M
W.140 x H.75 x D.80 cm
DNM-SD1580-00M
W.150 x H.75 x D.80 cm
DNM-SD1680-00M
W.160 x H.75 x D.80 cm
DNM-SD1880-00M
W.180 x H.75 x D.80 cm

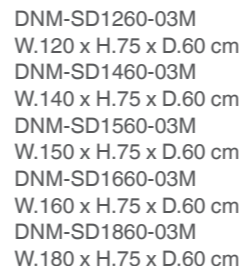

DNM-SD1260-03M
W.120 x H.75 x D.60 cm
DNM-SD1460-03M
W.140 x H.75 x D.60 cm
DNM-SD1560-03M
W.150 x H.75 x D.60 cm
DNM-SD1660-03M
W.160 x H.75 x D.60 cm
DNM-SD1860-03M
W.180 x H.75 x D.60 cm

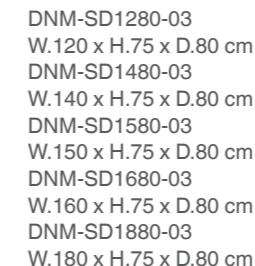

DNM-SD1280-03
W.120 x H.75 x D.80 cm
DNM-SD1480-03
W.140 x H.75 x D.80 cm
DNM-SD1580-03
W.150 x H.75 x D.80 cm
DNM-SD1680-03
W.160 x H.75 x D.80 cm
DNM-SD1880-03
W.180 x H.75 x D.80 cm



DNM-SD1280-03M
W.120 x H.75 x D.80 cm
DNM-SD1480-03M
W.140 x H.75 x D.80 cm
DNM-SD1580-03M
W.150 x H.75 x D.80 cm
DNM-SD1680-03M
W.160 x H.75 x D.80 cm
DNM-SD1880-03M
W.180 x H.75 x D.80 cm



DNM-MT1890-W
W.180 x H.75 x D.90 cm
DNM-MT2412-W
W.240 x H.75 x D.120 cm



DNM-MT1010-W
W.100 x H.75 x D.100 cm



DNM-RT0945-W19
W.90 x H.75 x D.45 cm
DNM-RT1045-W19
W.100 x H.75 x D.45 cm
DNM-RT1245-W19
W.120 x H.75 x D.45 cm
DNM-RT1060-W19
W.100 x H.75 x D.60 cm
DNM-RT1260-W19
W.120 x H.75 x D.60 cm



DNM-RT0945-W19M
W.90 x H.75 x D.45 cm
DNM-RT1045-W19M
W.100 x H.75 x D.45 cm
DNM-RT1245-W19M
W.120 x H.75 x D.45 cm
DNM-RT1060-W19M
W.100 x H.75 x D.60 cm
DNM-RT1260-W19M
W.120 x H.75 x D.60 cm



DNM-SD1260-30
W.120 x H.75 x D.60 cm
DNM-SD1460-30
W.140 x H.75 x D.60 cm
DNM-SD1560-30
W.150 x H.75 x D.60 cm
DNM-SD1660-30
W.160 x H.75 x D.60 cm
DNM-SD1860-30
W.180 x H.75 x D.60 cm



DNM-SD1260-03
W.120 x H.75 x D.60 cm
DNM-SD1460-03
W.140 x H.75 x D.60 cm
DNM-SD1560-03
W.150 x H.75 x D.60 cm
DNM-SD1660-03
W.160 x H.75 x D.60 cm
DNM-SD1860-03
W.180 x H.75 x D.60 cm

DNM-MT1890-WP (ไม้ส้อไฟ)
W.180 x H.75 x D.90 cm
DNM-MT2412-WP (ไม้ส้อไฟ)
W.240 x H.75 x D.120 cm

DYNAMIC



DNM-WS2490-4S
W.240 x H.75 x D.90 cm
DNM-WS2412-4S
W.240 x H.75 x D.120 cm



DNM-WS3690-6S
W.360 x H.75 x D.90 cm
DNM-WS3612-6S
W.360 x H.75 x D.120 cm



DNM-WS4890-8S
W.480 x H.75 x D.90 cm
DNM-WS4812-8S
W.480 x H.75 x D.120 cm



DNM-WC2245-T2F
W.220 x H.47 x D.45 cm



DNM-CB1265-DS
W.120 x H.55 x D.65 cm
DNM-CB1565-DS
W.150 x H.55 x D.65 cm



DNM-WC1145-1F
W.110 x H.41 x D.45 cm
DNM-WC1445-1F
W.140 x H.41 x D.45 cm



DNM-WC1445-T1F
W.140 x H.47 x D.45 cm



DNM-PSF6042-OT
W.60 x H.42 x D.xx cm
DNM-PSF7542-OT
W.75 x H.42 x D.xx cm
DNM-PSF8042-OT
W.80 x H.42 x D.xx cm
DNM-PSF9042-OT
W.90 x H.42 x D.xx cm
DNM-PSF1042-OT
W.100 x H.42 x D.xx cm

DNM-PSF1242-OT
W.120 x H.42 x D.xx cm
DNM-PSF1442-OT
W.140 x H.42 x D.xx cm
DNM-PSF1642-OT
W.160 x H.42 x D.xx cm
DNM-PSF1842-OT
W.180 x H.42 x D.xx cm



DNM-PSF6076-BT
W.60 x H.76 x D.xx cm
DNM-PSF7576-BT
W.75 x H.76 x D.xx cm
DNM-PSF8076-BT
W.80 x H.76 x D.xx cm
DNM-PSF9076-BT
W.90 x H.76 x D.xx cm
DNM-PSF1076-BT
W.100 x H.76 x D.xx cm

DNM-PSF1276-BT
W.120 x H.76 x D.xx cm
DNM-PSF1476-BT
W.140 x H.76 x D.xx cm
DNM-PSF1676-BT
W.160 x H.76 x D.xx cm
DNM-PSF1876-BT
W.180 x H.76 x D.xx cm

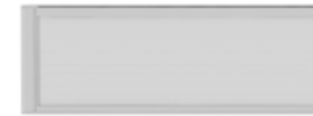

DNM-PSP6042-OT
W.60 x H.42 x D.xx cm
DNM-PSP7542-OT
W.75 x H.42 x D.xx cm
DNM-PSP8042-OT
W.80 x H.42 x D.xx cm
DNM-PSP9042-OT
W.90 x H.42 x D.xx cm
DNM-PSP1042-OT
W.100 x H.42 x D.xx cm

DNM-PSP1242-OT
W.120 x H.42 x D.xx cm
DNM-PSP1442-OT
W.140 x H.42 x D.xx cm
DNM-PSP1642-OT
W.160 x H.42 x D.xx cm
DNM-PSP1842-OT
W.180 x H.42 x D.xx cm



DNM-PSP6076-BT
W.60 x H.76 x D.xx cm
DNM-PSP7576-BT
W.75 x H.76 x D.xx cm
DNM-PSP8076-BT
W.80 x H.76 x D.xx cm
DNM-PSP9076-BT
W.90 x H.76 x D.xx cm
DNM-PSP1076-BT
W.100 x H.76 x D.xx cm

DNM-PSP1276-BT
W.120 x H.76 x D.xx cm
DNM-PSP1476-BT
W.140 x H.76 x D.xx cm
DNM-PSP1676-BT
W.160 x H.76 x D.xx cm
DNM-PSP1876-BT
W.180 x H.76 x D.xx cm

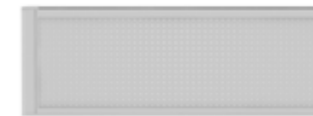

DNM-PSS6042-OT
W.60 x H.42 x D.xx cm
DNM-PSS7542-OT
W.75 x H.42 x D.xx cm
DNM-PSS8042-OT
W.80 x H.42 x D.xx cm
DNM-PSS9042-OT
W.90 x H.42 x D.xx cm
DNM-PSS1042-OT
W.100 x H.42 x D.xx cm

DNM-PSS1242-OT
W.120 x H.42 x D.xx cm
DNM-PSS1442-OT
W.140 x H.42 x D.xx cm
DNM-PSS1642-OT
W.160 x H.42 x D.xx cm
DNM-PSS1842-OT
W.180 x H.42 x D.xx cm



DNM-PSS6062-BT
W.60 x H.62 x D.xx cm
DNM-PSS7562-BT
W.75 x H.62 x D.xx cm
DNM-PSS8062-BT
W.80 x H.62 x D.xx cm
DNM-PSS9062-BT
W.90 x H.62 x D.xx cm
DNM-PSS1062-BT
W.100 x H.62 x D.xx cm

DNM-PSS1262-BT
W.120 x H.62 x D.xx cm
DNM-PSS1462-BT
W.140 x H.62 x D.xx cm
DNM-PSS1662-BT
W.160 x H.62 x D.xx cm
DNM-PSS1862-BT
W.180 x H.62 x D.xx cm

DYNAMIC

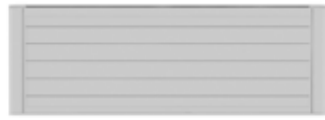

DNM-PSR6042-OT W.60 x H.42 x D.xx cm	DNM-PSR1242-OT W.120 x H.42 x D.xx cm
DNM-PSR7542-OT W.75 x H.42 x D.xx cm	DNM-PSR1442-OT W.140 x H.42 x D.xx cm
DNM-PSR8042-OT W.80 x H.42 x D.xx cm	DNM-PSR1642-OT W.160 x H.42 x D.xx cm
DNM-PSR9042-OT W.90 x H.42 x D.xx cm	DNM-PSR1842-OT W.180 x H.42 x D.xx cm
DNM-PSR1042-OT W.100 x H.42 x D.xx cm	



DNM-PSR6076-BT W.60 x H.76 x D.xx cm	DNM-PSR1276-BT W.120 x H.76 x D.xx cm
DNM-PSR7576-BT W.75 x H.76 x D.xx cm	DNM-PSR1476-BT W.140 x H.76 x D.xx cm
DNM-PSR8076-BT W.80 x H.76 x D.xx cm	DNM-PSR1676-BT W.160 x H.76 x D.xx cm
DNM-PSR9076-BT W.90 x H.76 x D.xx cm	DNM-PSR1876-BT W.180 x H.76 x D.xx cm
DNM-PSR1076-BT W.100 x H.76 x D.xx cm	



DNM-PSG6042-OT W.60 x H.42 x D.xx cm	DNM-PSG1242-OT W.120 x H.42 x D.xx cm
DNM-PSG7542-OT W.75 x H.42 x D.xx cm	DNM-PSG1442-OT W.140 x H.42 x D.xx cm
DNM-PSG8042-OT W.80 x H.42 x D.xx cm	DNM-PSG1642-OT W.160 x H.42 x D.xx cm
DNM-PSG9042-OT W.90 x H.42 x D.xx cm	DNM-PSG1842-OT W.180 x H.42 x D.xx cm
DNM-PSG1042-OT W.100 x H.42 x D.xx cm	



DNM-PSG6076-BT W.60 x H.76 x D.xx cm	DNM-PSG1276-BT W.120 x H.76 x D.xx cm
DNM-PSG7576-BT W.75 x H.76 x D.xx cm	DNM-PSG1476-BT W.140 x H.76 x D.xx cm
DNM-PSG8076-BT W.80 x H.76 x D.xx cm	DNM-PSG1676-BT W.160 x H.76 x D.xx cm
DNM-PSG9076-BT W.90 x H.76 x D.xx cm	DNM-PSG1876-BT W.180 x H.76 x D.xx cm
DNM-PSG1076-BT W.100 x H.76 x D.xx cm	



DNM-PSL6042-OT W.60 x H.42 x D.xx cm	DNM-PSL1242-OT W.120 x H.42 x D.xx cm
DNM-PSL7542-OT W.75 x H.42 x D.xx cm	DNM-PSL1442-OT W.140 x H.42 x D.xx cm
DNM-PSL8042-OT W.80 x H.42 x D.xx cm	DNM-PSL1642-OT W.160 x H.42 x D.xx cm
DNM-PSL9042-OT W.90 x H.42 x D.xx cm	DNM-PSL1842-OT W.180 x H.42 x D.xx cm
DNM-PSL1042-OT W.100 x H.42 x D.xx cm	



DNM-PSL6076-BT W.60 x H.76 x D.xx cm	DNM-PSL1276-BT W.120 x H.76 x D.xx cm
DNM-PSL7576-BT W.75 x H.76 x D.xx cm	DNM-PSL1476-BT W.140 x H.76 x D.xx cm
DNM-PSL8076-BT W.80 x H.76 x D.xx cm	DNM-PSL1676-BT W.160 x H.76 x D.xx cm
DNM-PSL9076-BT W.90 x H.76 x D.xx cm	DNM-PSL1876-BT W.180 x H.76 x D.xx cm
DNM-PSL1076-BT W.100 x H.76 x D.xx cm	

NEW DECO



NDS 800-60
W.80 x H.75 x D.60 cm
NDS 1000-60
W.100 x H.75 x D.60 cm
NDS 1200-60
W.120 x H.75 x D.60 cm
NDS 1500-60
W.150 x H.75 x D.60 cm
NDS 1600-60
W.160 x H.75 x D.60 cm
NDS 1800-60
W.180 x H.75 x D.60 cm



NDSS 800-68
W.80 x H.75 x D.60 x D.80 cm
NDSS 1000-68
W.100 x H.75 x D.60 x D.80 cm
NDSS 1200-68
W.120 x H.75 x D.60 x D.80 cm
NDSS 1500-68
W.150 x H.75 x D.60 x D.80 cm
NDSS 1600-68
W.160 x H.75 x D.60 x D.80 cm
NDSS 1800-68
W.180 x H.75 x D.60 x D.80 cm



NDLS 1512-66L
W.150 x H.75 x D.120 x D.60 x D.60 cm
NDLS 1512-66R
W.150 x H.75 x D.120 x D.60 x D.60 cm
NDLS 1612-66L
W.160 x H.75 x D.120 x D.60 x D.60 cm
NDLS 1612-66R
W.160 x H.75 x D.120 x D.60 x D.60 cm
NDLS 1812-66L
W.180 x H.75 x D.120 x D.60 x D.60 cm
NDLS 1812-66R
W.180 x H.75 x D.120 x D.60 x D.60 cm



NDLS 1512-86L
W.150 x H.75 x D.120 x D.80 x D.60 cm
NDLS 1512-86R
W.150 x H.75 x D.120 x D.80 x D.60 cm
NDLS 1612-86L
W.160 x H.75 x D.120 x D.80 x D.60 cm
NDLS 1612-86R
W.160 x H.75 x D.120 x D.80 x D.60 cm
NDLS 1812-86L
W.180 x H.75 x D.120 x D.80 x D.60 cm
NDLS 1812-86R
W.180 x H.75 x D.120 x D.80 x D.60 cm



NDS 800-80
W.80 x H.75 x D.80 cm
NDS 1000-80
W.100 x H.75 x D.80 cm
NDS 1200-80
W.120 x H.75 x D.80 cm
NDS 1500-80
W.150 x H.75 x D.80 cm
NDS 1600-80
W.160 x H.75 x D.80 cm
NDS 1800-80
W.180 x H.75 x D.80 cm



NDSS 800-86
W.80 x H.75 x D.80 x D.60 cm
NDSS 1000-86
W.100 x H.75 x D.80 x D.60 cm
NDSS 1200-86
W.120 x H.75 x D.80 x D.60 cm
NDSS 1500-86
W.150 x H.75 x D.80 x D.60 cm
NDSS 1600-86
W.160 x H.75 x D.80 x D.60 cm
NDSS 1800-86
W.180 x H.75 x D.80 x D.60 cm

NEW DECO



NDCN 1010-66
W.100 x H.75 x D.100 x D.60 x D.60 cm
NDCN 1212-66
W.120 x H.75 x D.120 x D.60 x D.60 cm



NDCN 1010-88
W.100 x H.75 x D.100 x D.80 x D.80 cm
NDCN 1212-88
W.120 x H.75 x D.120 x D.80 x D.80 cm



NDCD 800-60+KB 02
W.80 x H.75 x D.60 cm



NDCD 800-60S
W.80 x H.75 x D.60 cm



NDCN 1010-68
W.100 x H.75 x D.100 x D.60 x D.80 cm
NDCN 1212-68
W.120 x H.75 x D.120 x D.60 x D.80 cm



NDCN 1010-86
W.100 x H.75 x D.100 x D.80 x D.60 cm
NDCN 1212-86
W.120 x H.75 x D.120 x D.80 x D.60 cm



NDCD 1200-60S+KB 02
W.120 x H.75 x D.60 cm
NDCD 1500-80S+KB 02
W.150 x H.75 x D.80 cm



NDRD 1000-45L
W.100 x H.75 x D.45 cm
NDRD 1000-45R
W.100 x H.75 x D.45 cm



NDCN 6060
W.65 x H.75 x D.65 cm
NDCN 8080
W.85 x H.75 x D.85 cm



NDCN 6080
W.65 x H.75 x D.85 cm
NDCN 8060
W.85 x H.75 x D.65 cm



NDEX 1266-3Q
W.120 x H.2.8 x D.60 x D.60 cm
NDEX 1288-3Q
W.120 x H.2.8 x D.80 x D.80 cm



NDEX 1248-3Q
W.120 x H.2.8 x D.80 x D.40 cm
NDEX 1284-3Q
W.120 x H.2.8 x D.40 x D.80 cm



NDEX 6060-1Q
W.65 x H.2.8 x D.65 cm
NDEX 8080-1Q
W.85 x H.2.8 x D.85 cm



NDEX 6080-1Q
W.65 x H.2.8 x D.85 cm
NDEX 8060-1Q
W.85 x H.2.8 x D.65 cm



ACSL001
W.10 x H.72 cm



ACSL002
W.50 x H.72 x D.15 cm



ACSL003
W.5 x H.72 cm

NEW DECO



NDMT 1000R
R.100 x H.75 cm
NDMT 1200R
R.120 x H.75 cm



NDMT 1800-90
W.180 x H.75 x D.90 cm
NDMT 2000-11
W.200 x H.75 x D.110 cm
NDMT 2400-12
W.240 x H.75 x D.120 cm
NDMT 3600-12
W.360 x H.75 x D.120 cm



NDCT 6060-1Q
W.65 x H.75 x D.65 cm



NDCT 700-60
W.70 x H.75 x D.60 cm
NDCT 1400-60
W.140 x H.75 x D.60 cm
NDCT 2100-60
W.210 x H.75 x D.60 cm

NOBLE

Consider this if you are thinking about concentration and privacy, and the importance of individual work

NOBLE EXECUTIVE DESK

With its distinctive clean lines and taste for details, the NOBLE Executive Desk offers an elegant and modern design for dynamic managers: Available in rectangular and elliptical shapes with powder-coated finishes on its leg structure.



Individual work space ranges from a simple freestanding table to back-to-back or face-to-face workstations with clean lines and contemporary looks.

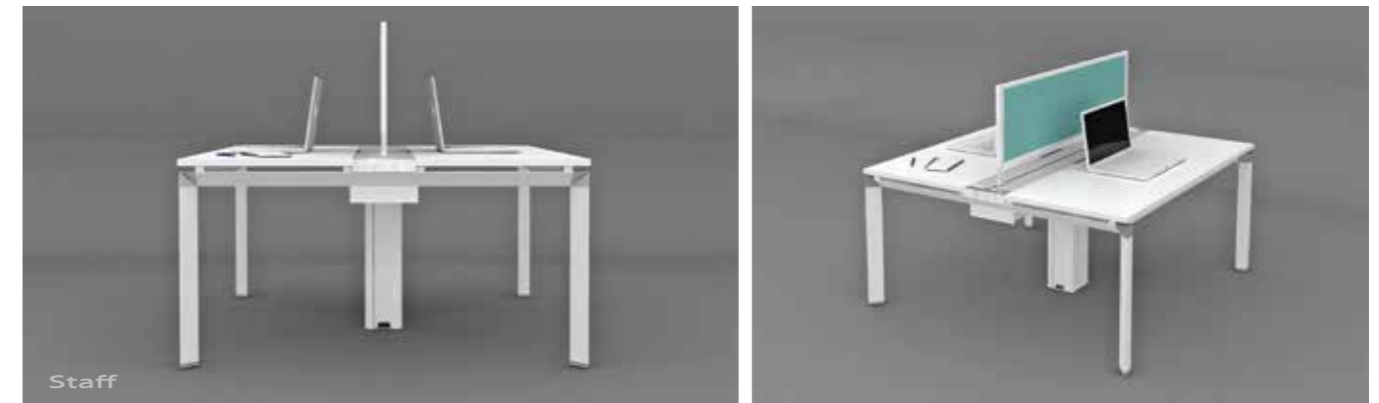

NOBLE STAFF

To offer maximum flexibility, and in order to suit individual or team requirements, NOBLE bench desk configurations are equipped with middle legs recessed from the desk edges.

Work surface options include laminated and melamine surfaces with optional metal modesty panels. Pedestals and return cabinets are available to complement the freestanding table to form a functional solution.



NOBLE

NOBLE CALL

120-DEGREE LINEAR WORKSTATION

120-degree configuration offers inviting workstations and comfortable personal space. The minimal structure and translucent elements make spaces feel larger and more open.



90-DEGREE CLUSTER OF 4

These versatile table legs, as well as office desks and gang chairs meet the requirements to form a continuous line of product category. In short, the leading features of this system stands out its material uniqueness and technical solutions, perfectly combining elegance and modern design.

NOBLE CONFERENCE

Segmented long meeting or teamwork desks are formed by standard desks, linked with bridging units, supported by under-beam structures.



Power and data is routed vertically through a flexible cable spine and distributed horizontally via cable tray fitted between cross beams.

BRAVO



BR2F-60
W.41.6 x H.45 x D.50 cm
BR2F-80
W.41.6 x H.45 x D.62 cm



BR3F-60
W.41.6 x H.45 x D.50 cm
BR3F-80
W.41.6 x H.45 x D.62 cm



BR2M-50
W.41.6 x H.65 x D.50 cm
BR2M-60
W.41.6 x H.65 x D.60 cm



BR3M-50
W.41.6 x H.65 x D.50 cm
BR3M-60
W.41.6 x H.65 x D.60 cm



BR3P-60
W.41.6 x H.75 x D.60 cm
BR3P-80
W.41.6 x H.75 x D.80 cm



NDMC 4016-CC
W.40 x H.160 x D.40 cm



NDMC 4016-OC
W.40 x H.160 x D.40 cm



NDMC 4016-OO
W.40 x H.160 x D.40 cm



BRLC 4083-C
W.40 x H.83 x D.40 cm



BRLC 4083-O
W.40 x H.83 x D.40 cm



BRMC 8016-CC
W.80 x H.160 x D.40 cm



BRMC 8016-SC
W.80 x H.160 x D.40 cm



BRMC 8016-OC
W.80 x H.160 x D.40 cm



BRMC 9016-FC
W.90 x H.160 x D.40 cm



BRLC 8083-C
W.80 x H.83 x D.40 cm



BRLC 8083-S
W.80 x H.83 x D.40 cm



BRLC 8083-O
W.80 x H.83 x D.40 cm



BRLC 9083-F
W.90 x H.83 x D.40 cm

BRAVO



BRMC 8016-SO
W.80 x H.160 x D.40 cm



BRMC 8016-OO
W.80 x H.160 x D.40 cm



BRMC 9016-FO
W.90 x H.160 x D.40 cm



BRHC 8020-CC
W.80 x H.200 x D.40 cm



BRHC 8020-SC
W.80 x H.200 x D.40 cm



BRHC 8020-OC
W.80 x H.200 x D.40 cm



BRHC 9020-FC
W.90 x H.200 x D.40 cm



BRMC 8016-SG
W.80 x H.160 x D.40 cm



BRMC 8016-OG
W.80 x H.160 x D.40 cm



BRMC 9016-FG
W.90 x H.160 x D.40 cm



BRHC 8020-SO
W.80 x H.200 x D.40 cm



BRHC 8020-OO
W.80 x H.200 x D.40 cm



BRHC 9020-FO
W.90 x H.200 x D.40 cm



NDHC 4020-CC
W.40 x H.200 x D.40 cm



NDHC 4020-OC
W.40 x H.200 x D.40 cm



NDHC 4020-OO
W.40 x H.200 x D.40 cm



BRHC 8020-SG
W.80 x H.200 x D.40 cm



BRHC 8020-OG
W.80 x H.200 x D.40 cm



BRHC 9020-FG
W.90 x H.200 x D.40 cm

DYNAMIC



DNM-PD673S-LMC
W.39.5 x H.67 x D.50 cm



DNM-PD673S-MAC
W.39.5 x H.67 x D.50 cm



DNM-CB1263-RVL
W.42 x H.115 x D.60 cm
DNM-CB1263-RVR
W.42 x H.115 x D.60 cm



DNM-CB1283-RVL
W.42 x H.115 x D.80 cm
DNM-CB1283-RVR
W.42 x H.115 x D.80 cm



DNM-CB1563-RVL
W.42 x H.155 x D.60 cm
DNM-CB1563-RVR
W.42 x H.155 x D.60 cm



DNM-CB1583-RVL
W.42 x H.155 x D.80 cm
DNM-CB1583-RVR
W.42 x H.155 x D.80 cm



DNM-CB8483-WOM
W.80 x H.83 x D.40 cm



DNM-CB8412-WOM
W.80 x H.125 x D.40 cm



DNM-CB8415-WOM
W.80 x H.156 x D.40 cm



DNM-CB8420-WOM
W.80 x H.200 x D.40 cm



DNM-CT6060W
W.60 x H.45 x D.60 cm
DNM-CT9060W
W.90 x H.45 x D.60 cm



DNM-CT6060G
W.60 x H.45 x D.60 cm
DNM-CT9060G
W.90 x H.45 x D.60 cm



DNM-MD4040-ES
W.40 x H.40 x D.1.2 cm
DNM-MD6040-ES
W.60 x H.40 x D.1.2 cm
DNM-MD8040-ES
W.80 x H.40 x D.1.2 cm
DNM-MD1040-ES
W.100 x H.40 x D.1.2 cm
DNM-MD1240-ES
W.120 x H.40 x D.1.2 cm

DNM-MD1340-ES
W.130 x H.40 x D.1.2 cm
DNM-MD1440-ES
W.140 x H.40 x D.1.2 cm
DNM-MD1640-ES
W.160 x H.40 x D.1.2 cm
DNM-MD1840-ES
W.180 x H.40 x D.1.2 cm



DNM-CB8483-GOA
W.80 x H.83 x D.40 cm



DNM-CB8412-GOA
W.80 x H.125 x D.40 cm



DNM-CB8415-GOA
W.80 x H.156 x D.40 cm



DNM-CB8420-GOA
W.80 x H.200 x D.40 cm



DNM-PS4040-LG
W.40 x H.40 x D.8 cm
DNM-PS1240-LG
W.120 x H.40 x D.8 cm
DNM-PS1440-LG
W.140 x H.40 x D.8 cm
DNM-PS1640-LG
W.160 x H.40 x D.8 cm



DNM-PS4040-AC
W.40 x H.40 x D.6 cm
DNM-PS1240-AC
W.120 x H.40 x D.6 cm
DNM-PS1440-AC
W.140 x H.40 x D.6 cm
DNM-PS1640-AC
W.160 x H.40 x D.6 cm



DNM-AC6115-PU2A
W.61 x H.90 x D.15 cm



DNM-AC6047-SW
W.60 x H.72 x D.40 cm

NEW DECO



NDCT 700-60
W.70 x H.75 x D.60 cm
NDCT 1400-60
W.140 x H.75 x D.60 cm
NDCT 2100-60
W.210 x H.75 x D.60 cm



ND2F-50
W.41.6 x H.45 x D.50 cm
ND2F-62
W.41.6 x H.45 x D.62 cm



ND3F-50
W.41.6 x H.45 x D.50 cm
ND3F-62
W.41.6 x H.45 x D.62 cm



NDMC 4016-CC
W.40 x H.160 x D.40 cm



NDMC 4016-OC
W.40 x H.160 x D.40 cm



NDMC 4016-OO
W.40 x H.160 x D.40 cm



ND2M-50
W.41.6 x H.65 x D.50 cm
ND2M-60
W.41.6 x H.65 x D.60 cm



ND3M-50
W.41.6 x H.65 x D.50 cm
ND3M-60
W.41.6 x H.65 x D.60 cm



ND3P-60
W.41.6 x H.75 x D.60 cm
ND3P-80
W.41.6 x H.75 x D.80 cm



NDLC 4083-C
W.40 x H.83 x D.40 cm



NDLC 4083-O
W.40 x H.83 x D.40 cm



NDMC 8016-CC
W.80 x H.160 x D.40 cm



NDMC 8016-SC
W.80 x H.160 x D.40 cm



NDMC 8016-OC
W.80 x H.160 x D.40 cm



NDMC 9016-FC
W.90 x H.160 x D.40 cm



NDLC 8083-C
W.80 x H.83 x D.40 cm



NDLC 8083-S
W.80 x H.83 x D.40 cm



NDLC 8083-O
W.80 x H.83 x D.40 cm



NDLC 9083-F
W.90 x H.83 x D.40 cm

NEW DECO



NDMC 8016-SO
W.80 x H.160 x D.40 cm



NDMC 8016-OO
W.80 x H.160 x D.40 cm



NDMC 9016-FO
W.90 x H.160 x D.40 cm



NDHC 8020-CC
W.80 x H.200 x D.40 cm



NDHC 8020-SC
W.80 x H.200 x D.40 cm



NDHC 8020-OC
W.80 x H.200 x D.40 cm



NDHC 9020-FC
W.90 x H.200 x D.40 cm



NDMC 8016-SG
W.80 x H.160 x D.40 cm



NDMC 8016-OG
W.80 x H.160 x D.40 cm



NDMC 9016-FG
W.90 x H.160 x D.40 cm



NDHC 8020-SO
W.80 x H.200 x D.40 cm



NDHC 8020-OO
W.80 x H.200 x D.40 cm



NDHC 9020-FO
W.90 x H.200 x D.40 cm



NDHC 4020-CC
W.40 x H.200 x D.40 cm



NDHC 4020-OC
W.40 x H.200 x D.40 cm



NDHC 4020-OO
W.40 x H.200 x D.40 cm



NDHC 8020-SG
W.80 x H.200 x D.40 cm



NDHC 8020-OG
W.80 x H.200 x D.40 cm



NDHC 9020-FG
W.90 x H.200 x D.40 cm

FOLDING TABLE

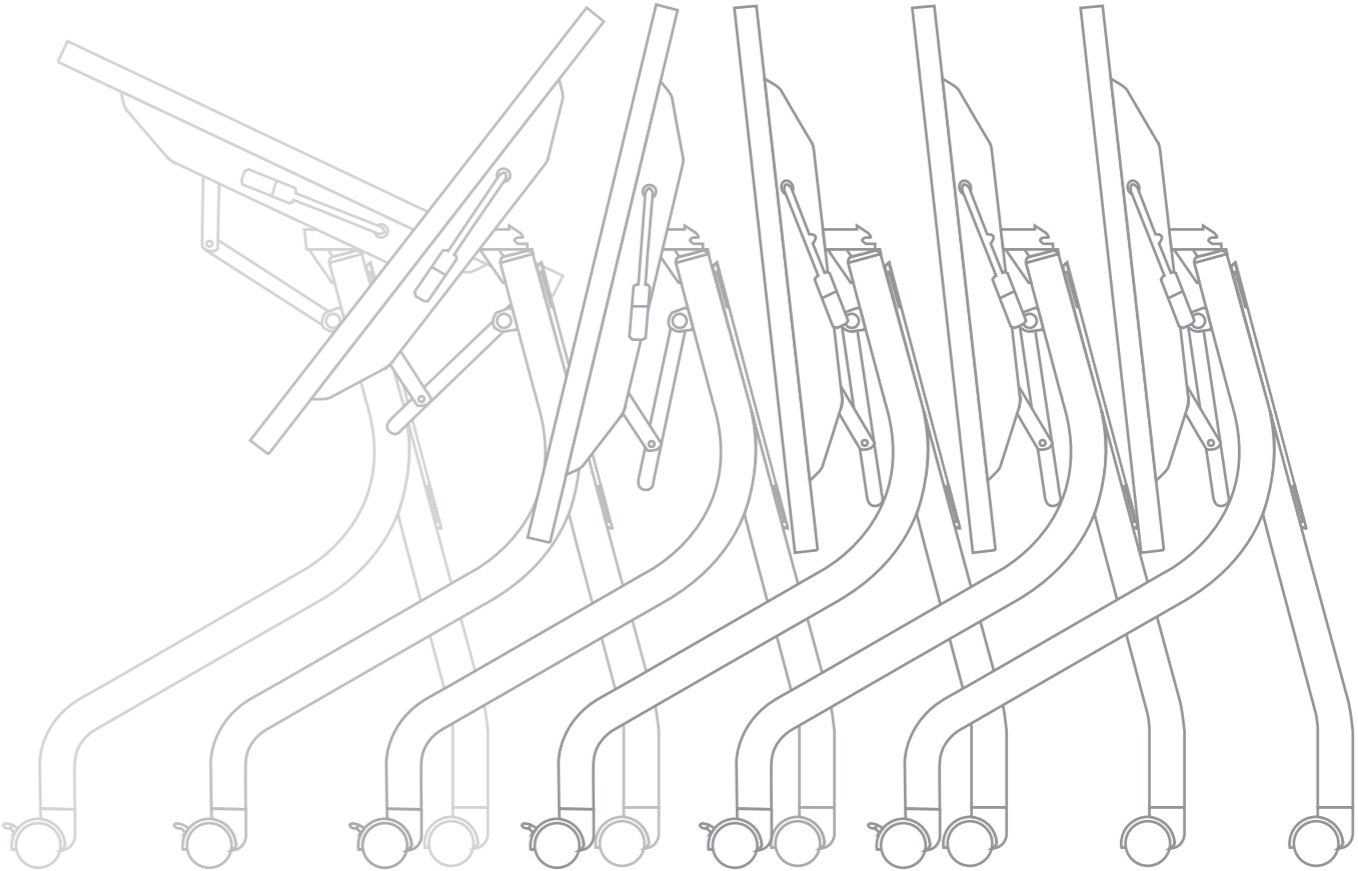

HARRIER

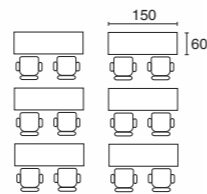

Communicating, sharing and training in the smallest space but with big value.

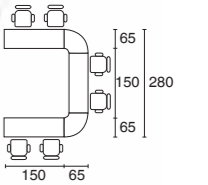

Pinboard / Whiteboard

HRMS-WR10

W1000 x D590 x H1600 mm.
Can be compact; double-sided board covered in grey felt, whiteboard with enameled sheet steel in order to use magnets and pens with clamp-on pinstripe.



Podium

HRPO-110

W540 x D590 x H1100 mm.
It is mobile, with desk tops and modesty coated panels made of perforated steel, including space for company logos.

Folding step for stackable tables



Stackable tables



CONFIGURATION

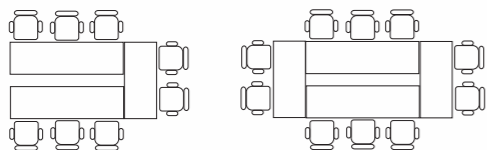
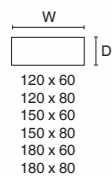
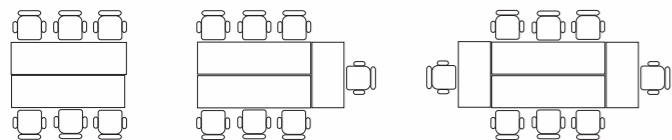

HRMD2-180

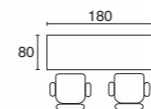

CONFIGURATION

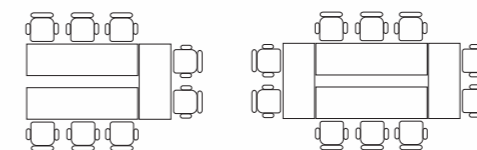
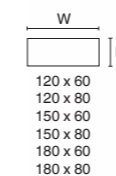
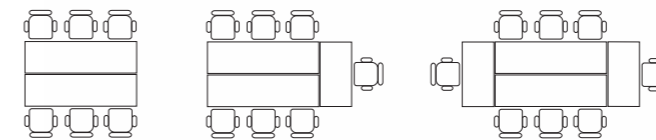

AFD-1580M

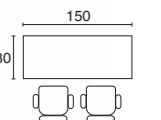

AFD-1560

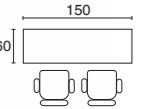

C-FLASH

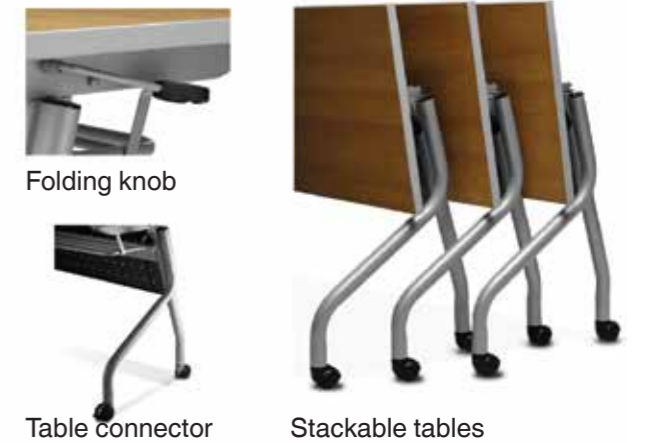
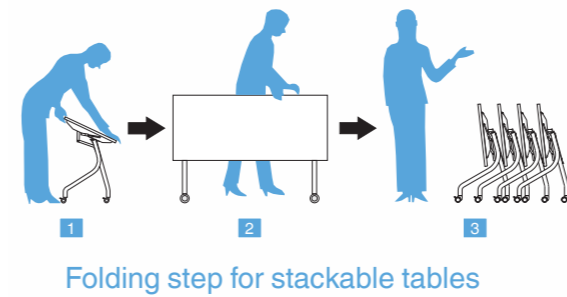
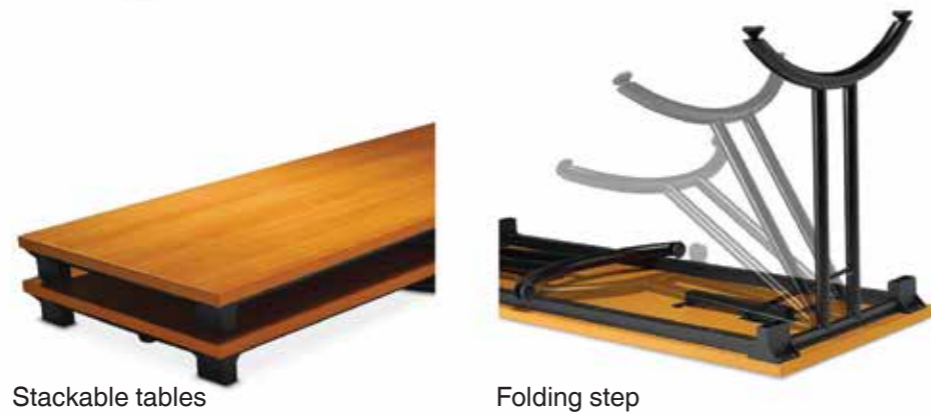

CONFIGURATION

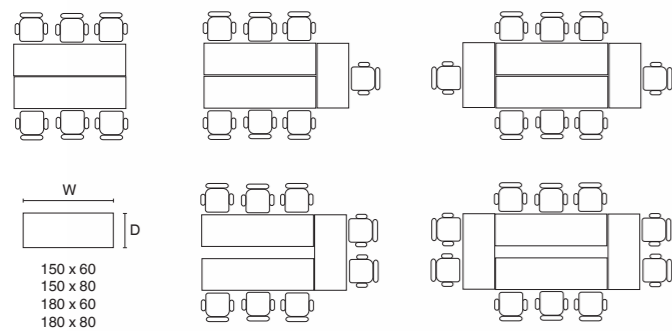

CONFIGURATION

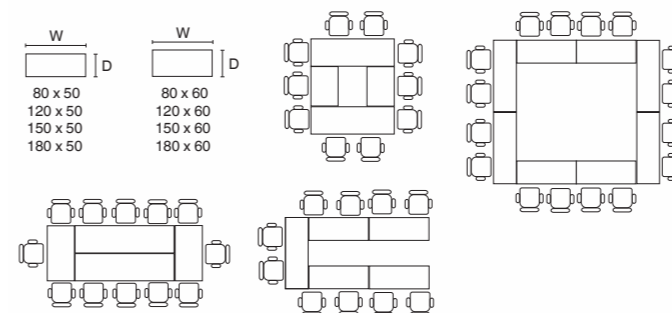

HARRIER SERIES

MOBILE & FREESTANDING DESK MOBILE

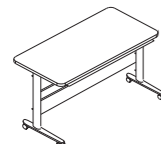

MOBILE/FOLDING DESK			Material
Dimension	W120 x D60 x H74	MFD-120	ML, HPL
	150 x 60 x 74	MFD-150	ML, HPL
	180 x 60 x 74	MFD-180	ML, HPL

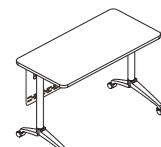

MOBILE DESK 60 cm.			Material
Dimension	W120 x D60 x H74	HRMD1-120	ML, HPL
	150 x 60 x 74	HRMD1-150	ML, HPL
	180 x 60 x 74	HRMD1-180	ML, HPL



MOBILE DESK 80 cm.			Material
Dimension	W120 x D80 x H74	HRMD2-120	ML, HPL
	150 x 80 x 74	HRMD2-150	ML, HPL
	180 x 80 x 74	HRMD2-180	ML, HPL



FREESTANDING DESK			Material
Dimension	W120 x D60 x H74	HRFD1-120	ML, HPL
	150 x 60 x 74	HRFD1-150	ML, HPL
	180 x 60 x 74	HRFD1-180	ML, HPL

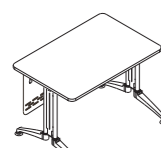

FREESTANDING DESK			Material
Dimension	W120 x D80 x H74	HRFD2-120	ML, HPL
	150 x 80 x 74	HRFD2-150	ML, HPL
	180 x 80 x 74	HRFD2-180	ML, HPL

PODIUM



PODIUM			Material
Dimension	W54 x D59 x H110	HRPO-110	ML, HPL

WHITE BOARD CORE 2 FACE



WHITE BOARD CORE 2 FACE		
Dimension	W100 x D59 x H160	HRMS-WB10

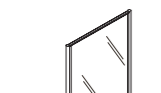

WHITE BOARD CORE 2 FACE ORGANIZATION RAILS 2 FACE		
Dimension	W100 x D59 x H160	HRMS-FR10

FOLDING CONFERENCE TABLE



A-FLASH			Material
Dimension	W150 x D60 x H74	AFD-1560	ML/Epoxy, ML/Chromium
	150 x 80 x 74	AFD-1580	ML/Epoxy, ML/Chromium
	180 x 60 x 74	AFD-1860	ML/Epoxy, ML/Chromium
	180 x 80 x 74	AFD-1880	ML/Epoxy, ML/Chromium



A-FLASH WITH MODESTY PANEL			Material
Dimension	W150 x D60 x H74	AFD-1560M	ML/Epoxy, ML/Chromium
	150 x 80 x 74	AFD-1580M	ML/Epoxy, ML/Chromium
	180 x 60 x 74	AFD-1860M	ML/Epoxy, ML/Chromium
	180 x 80 x 74	AFD-1880M	ML/Epoxy, ML/Chromium



C-FLASH			Material
Dimension	W150 x D60 x H75	CF-1560	ML, HPL
	150 x 80 x 75	CF-1580	ML, HPL
	180 x 60 x 75	CF-1860	ML, HPL
	180 x 80 x 75	CF-1880	ML, HPL



C-FLASH WITH MODESTY PANEL			Material
Dimension	W150 x D60 x H75	CFM-1560	ML, HPL
	150 x 80 x 75	CFM-1580	ML, HPL
	180 x 60 x 75	CFM-1860	ML, HPL
	180 x 80 x 75	CFM-1880	ML, HPL

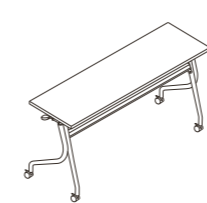

Y-FLASH			Material
Dimension	W80 x D50 x H75	YF-8050	ML, HPL
	80 x 60 x 75	YF-8060	ML, HPL
	120 x 50 x 75	YF-1250	ML, HPL
	120 x 60 x 75	YF-1260	ML, HPL
	150 x 50 x 75	YF-1550	ML, HPL
	150 x 60 x 75	YF-1560	ML, HPL
	180 x 50 x 75	YF-1850	ML, HPL
	180 x 60 x 75	YF-1860	ML, HPL

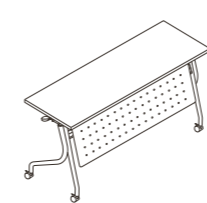

Y-FLASH WITH MODESTY PANEL			Material
Dimension	W80 x D50 x H75	YF-8050M	ML, HPL
	80 x 60 x 75	YF-8060M	ML, HPL
	120 x 50 x 75	YF-1250M	ML, HPL
	120 x 60 x 75	YF-1260M	ML, HPL
	150 x 50 x 75	YF-1550M	ML, HPL
	150 x 60 x 75	YF-1560M	ML, HPL
	180 x 50 x 75	YF-1850M	ML, HPL
	180 x 60 x 75	YF-1860M	ML, HPL

PARTITION

Simple & Flexible System

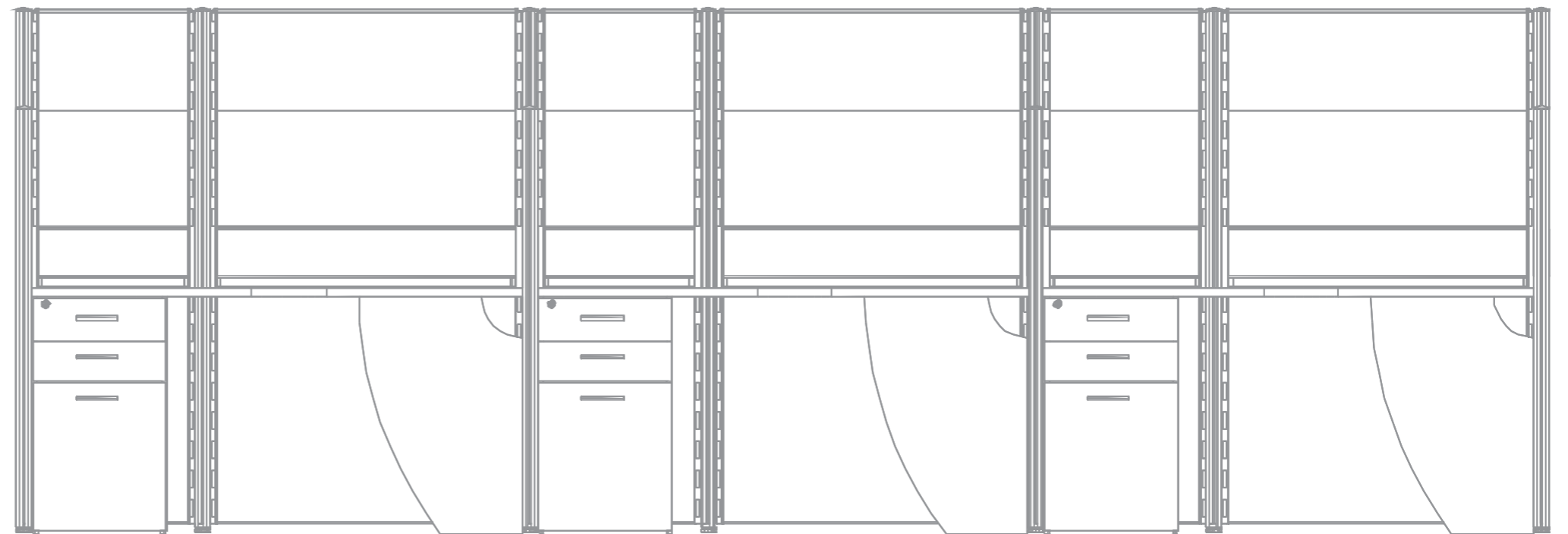

SERIES 4

While providing a professional setting to conduct business effectively, this powerful workstation has become a critical element to drive the dynamic and efficient organizations of today.



Multiple designs are available to suit individual needs that are conducive to working environments with comfortable walkways.

Statement of line.

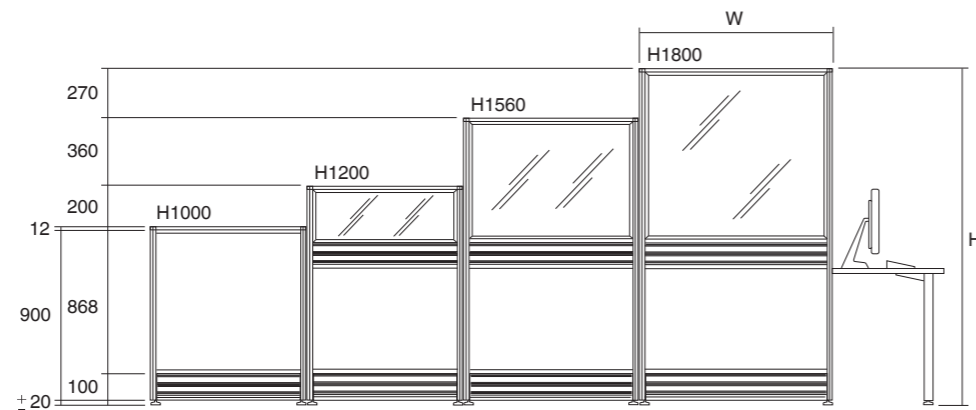

50 mm. thickness aluminium frame
Standard width options are : 400 / 600 / 750 / 800 / 900 / 1000 / 1200 mm. Standard height options are : 1000 / 1200 / 1560 / 1800 mm.

Various Junction



X-junction

T-junction

L-junction

Various junctions in the Series 4 panel system make its connections universal and versatile.

Light Grey
Maple
Beech
Cherry



25 mm. thick work tops in melamine or HPL chip board with 2 mm. PVC edge.

SERIES 4

Accessories



Keyboard Tray



CPU Holder

Wire Mangement



Middle raceway for easy & convenience access to power & data socket.



Base raceway for hidden & conceal wire management

END CAP AND CONNECTOR

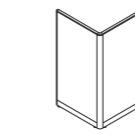

CONNECTOR/TWO-WAY-90 [6C2]

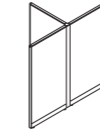

CONNECTOR/THREE-WAY-90 [6C3]

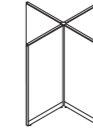

CONNECTOR/FOUR-WAY-90 [6C4]

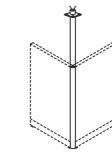

L-CONNECTOR [6PPL]

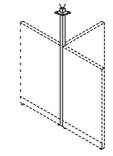

T-CONNECTOR [6PPT]

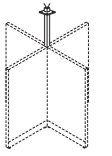

X-CONNECTOR [6PPX]

POWER POLE

PANEL

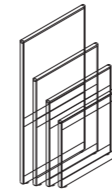

FULL FABRIC
FULL FABRIC WITH MIDDLE UTILITY PANEL
FULL FABRIC WITH BOTTOM UTILITY PANEL
FULL FABRIC WITH MIDDLE AND BOTTOM UTILITY PANEL

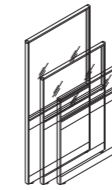

HALF CLEAR GLASS PANEL
HALF CLEAR GLASS WITH MIDDLE UTILITY PANEL
HALF CLEAR GLASS WITH BOTTOM UTILITY PANEL
HALF CLEAR GLASS WITH MIDDLE AND BOTTOM UTILITY PANEL

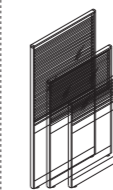

HALF SAND-BLAST GLASS PANEL
HALF SAND-BLAST GLASS WITH MIDDLE UTILITY PANEL
HALF SAND-BLAST WITH BOTTOM UTILITY GLASS PANEL
HALF SAND-BLAST GLASS WITH MIDDLE AND BOTTOM UTILITY PANEL

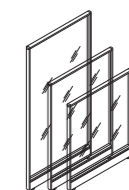

FULL GLASS PANEL
FULL GLASS WITH BOTTOM UTILITY PANEL
HALF SAND-BLAST GLASS WITH MIDDLE UTILITY PANEL

COUNTER

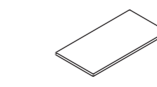

STANDARD WORK SURFACES [6WSST]

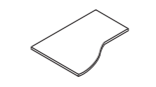

S-SHAPE WORK SURFACES [6WSSS]

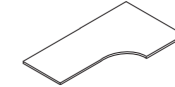

L-SHAPE WORK SURFACES

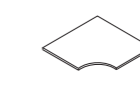

CORNER WORK SURFACES

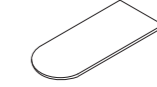

U-SHAPE WORK SURFACES



SEMI-CIRCLE WORK SURFACES: TURN CORNER WORK SURFACES

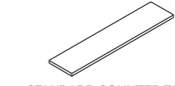

STANDARD COUNTER TOPS [6CTST]

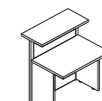

4CTN 07

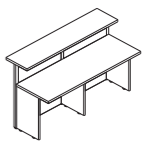

4CTN 07

SUPPORTS



SIDE END PANEL [6SEPN]

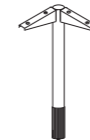

TOBE LEGS

STABILIZER

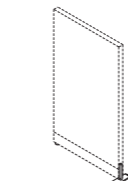

STABILIZER [6STB]

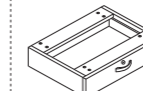

1 DRAWER



4CTN 05



4CTN 05



4CTN 04



4CTN 06

STORAGE

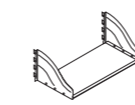

HANGING BOOK SHELF [6BSH]

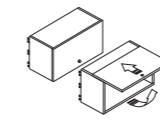

OVERHEAD HANGING CABINET [6COH]

SERIES 7

Today, business is achieved by utilizing the concept of brilliance, innovation and rapid adaptability. Likewise, SERIES 7 is designed with unprecedented technology and communication support.

Constructed with basic integrated components, SERIES 7 responds quickly to the flexible demands of dynamic workforces by creating hundreds of different configurations for every job function.

Cultural Diversity



SERIES 7 thoughtfully integrates the application of freestanding and panel-mounted configurations, allowing you to configure private, semi-private and highly interactive areas according to your individual needs.

Statement of line.

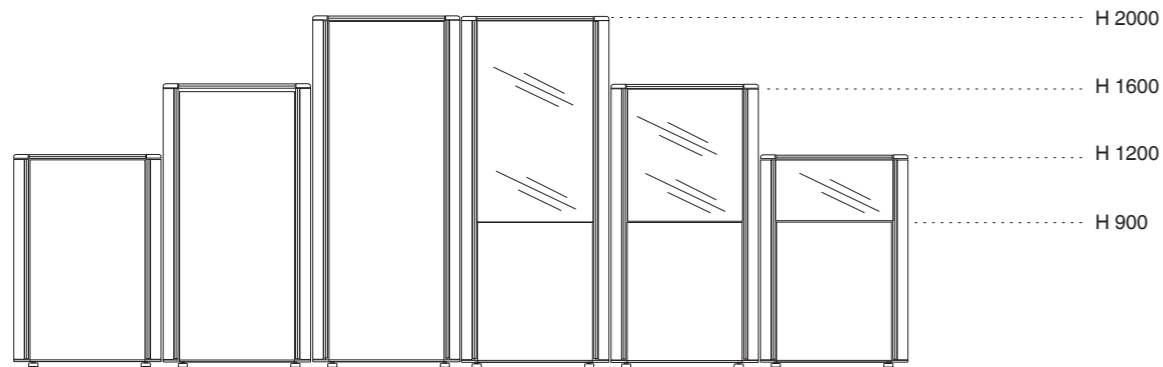

W : 600 / 700 / 750 / 800 / 900 / 1000 / 1200 mm.



SERIES 7 allows easy configuration; more flexibility, more aesthetic choices, more power access options and more means to help you respond to never-ending organizational change.

Featuring clean and simple lines, SERIES 7 provides durable, lasting value without compromising visual appeal.

Easy to configure



SERIES 7 provides practical 90 and 120-degree angles for optimum flexibility. Wide finishing screens provide space division and privacy as well as contributes to the distinctive aesthetic.

SERIES 7

SERIES 7 is designed for flexibility, easy adaptation, and above all, functionality. Providing solutions and flair on its own ... SERIES 7 has a wide array of work surfaces, storage, mobile or static privacy options, allowing a free rein to match and configure for taking care of tasks; open-style, closed, interactive or all of the above.

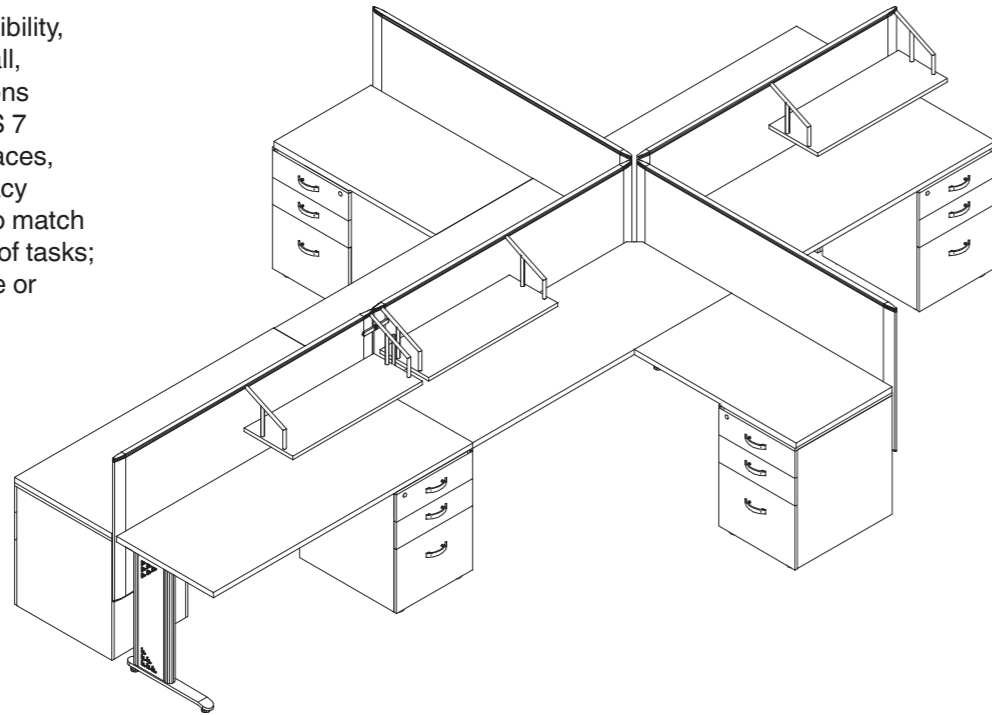

Interconnectivity



WIRE HOLDER



WIRE MANAGEMENT ON TABLE



INNER STRUCTURE OF WIRE SYSTEM

Privacy screen



ADJUSTABLE HANGING HALF ALUMINIUM WITH FABRIC



ADJUSTABLE HANGING FULL FABRIC



ADJUSTABLE HANGING HALF GLASS WITH FABRIC



POLYCARBONATE



SILVER POWDER COATED PERFORATE STEEL



FIXED ON WORKTOP FULL FABRIC

SERIES 7

Freedom of Connectivity

The uniqueness of SERIES 7 is in its simple and dynamic design, which delivers a diverse and infinite geometry for planning. The people accommodates planning and angle connections at 120-degree intervals, greatly enlarging the compass of connections and planning possibilities.

SERIES 7 is a solid pole structure that serves as an architectural framework for exterior workspaces by acting as a support or workstation.

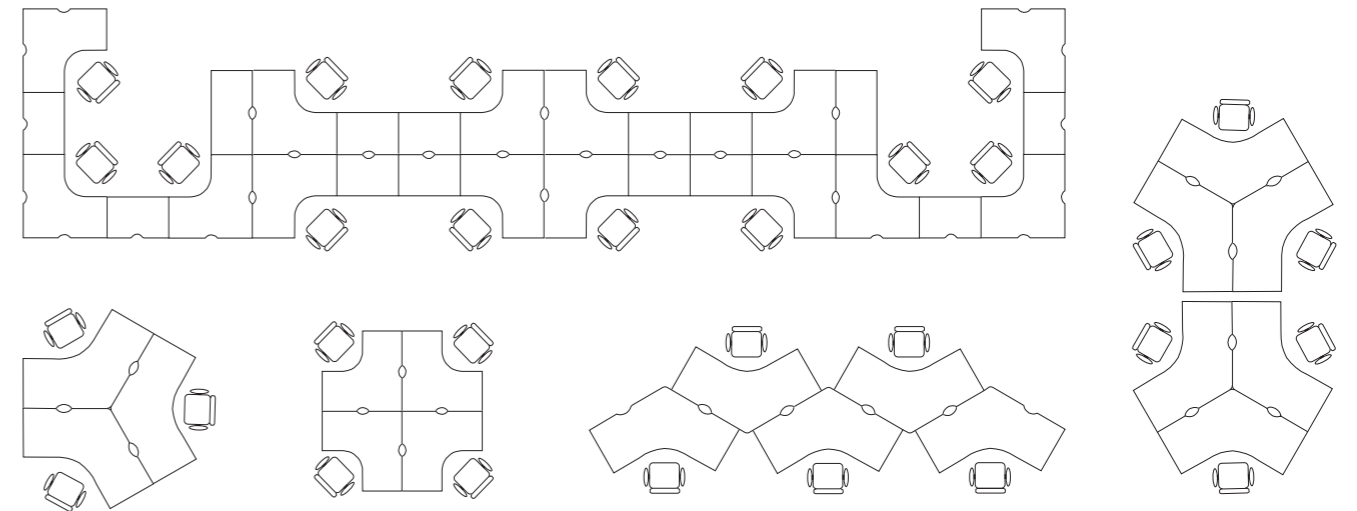

Accessories



HANGING SHELF



HANGING CABINET



PENCIL TRAY/PAPER TRAY

SERIES 8

Management styles



SERIES 8 is a simple structure panel system. Different heights of panels can be selected. Open or confined office space is easily achieved to suit different office layouts. What's more, the SERIES 8 panel system is compatible with various other panels, such as the wooden panel, PLANO-I, PLANO-L, and post legs, etc. Additionally, its powerful horizontal and vertical frames carry wiring systematically and throughout the workstation. SERIES 8 is definitely a clean and functional system for dynamic office settings.



Wall ventilation.

Ergonomics Shape

The 28 mm. worktop with melamine laminate was designed with its shape for maximum comfort, efficiency, and safety. This work surface is resistant to cigarette burns, scratches, heat and stains.



Statement of line.

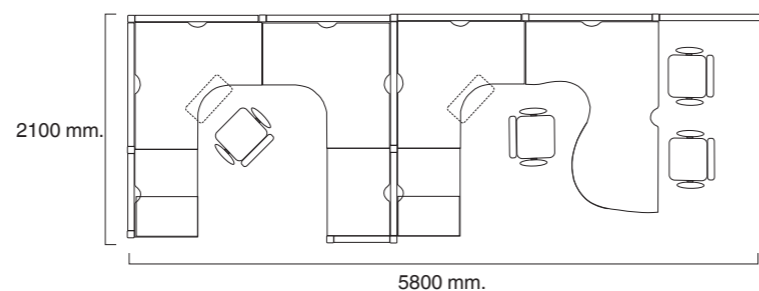

Staff workspaces



Modern multi-functional and multi-style office space with personality:

The scientific office design of SERIES 8 is engineered according to the shape of the human body, and builds a comfortable office environment, with which one can reach the equivalence of an open working space with privacy and safeguarding needs. SERIES 8 is dedicated to setting up a series of solutions for office spaces and is always seeking for new changes.



Versatile configurations leverage personal and cluster communications.

Series 8 posts allow hanging cabinets or shelves at different height levels.



Statement of line.

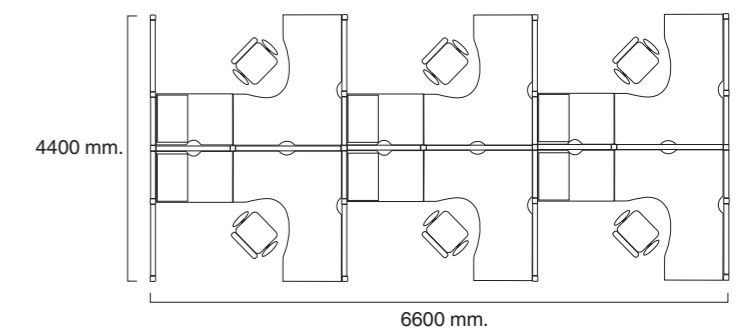

SERIES 8

Reception areas



A table mounted with a free-standing screen system, designed with a die-cast aluminium framework to produce a fabric effect: Future proofing is achieved through the system's accurate framework, where modular and mechanical linking ensures easy re-configuration.

ACCESSORIES



KEYBOARD TRAY



HANGING BOOK SHELF



HANGING CABINET



COUNTER

Statement of line.

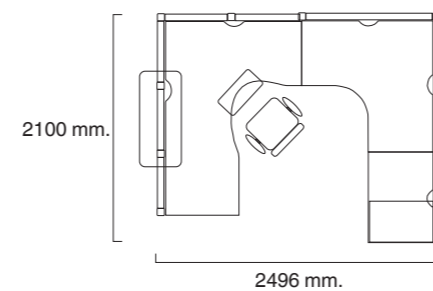

POWERFUL WIRE MANAGEMENT SYSTEM

In order to suit the needs of modern automatic offices, the SERIES 8 wire management system provides a large space to take in the horizontal and vertical lines. It is not only safe and reliable, but also space-saving and helps to promote work efficiency.

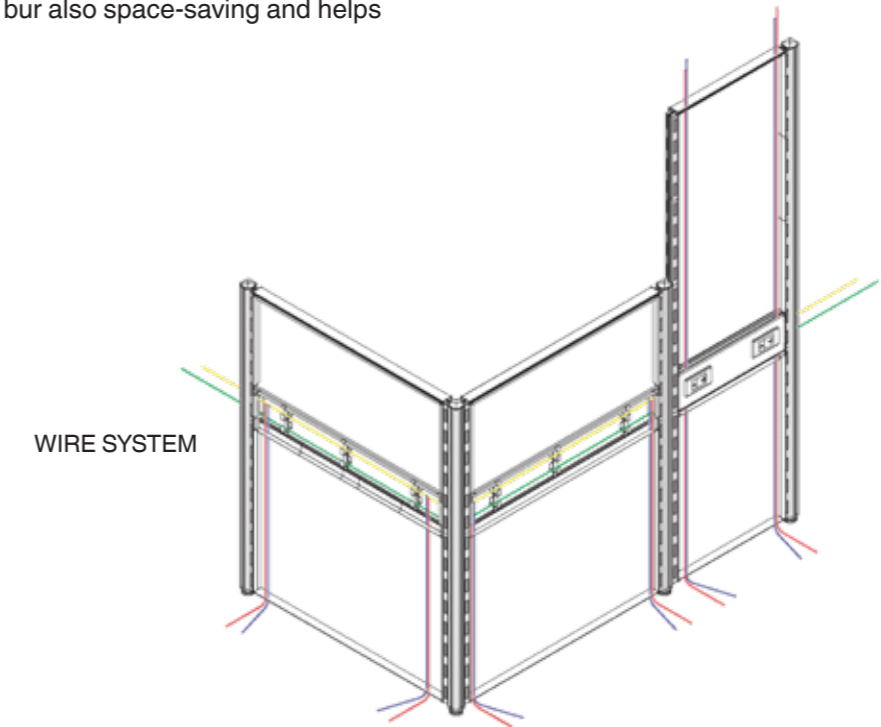

Electrical outlets are installed on the panel with utility channels.



The middle and bottom utility channels provide excellent wire management.

Statement of line.

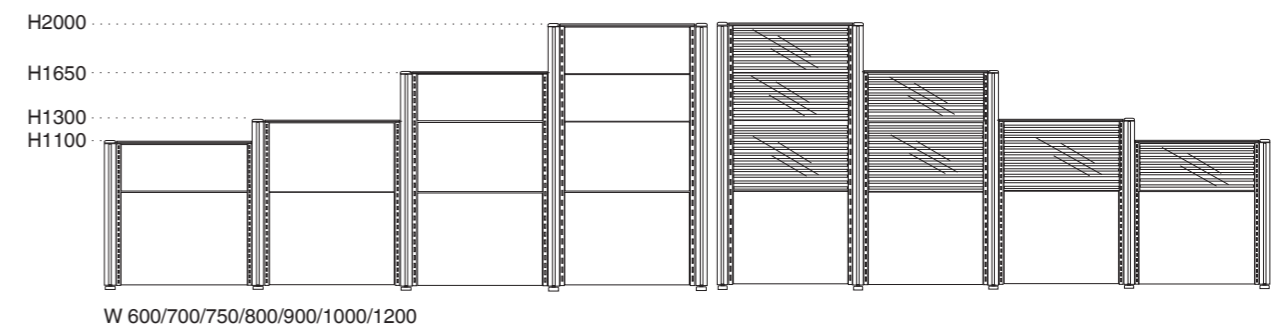

SEATING & LOUNGE

**What is needed is a high quality product.
Easier to use The chair provides dynamic
support without the need to manually
adjust the user.**

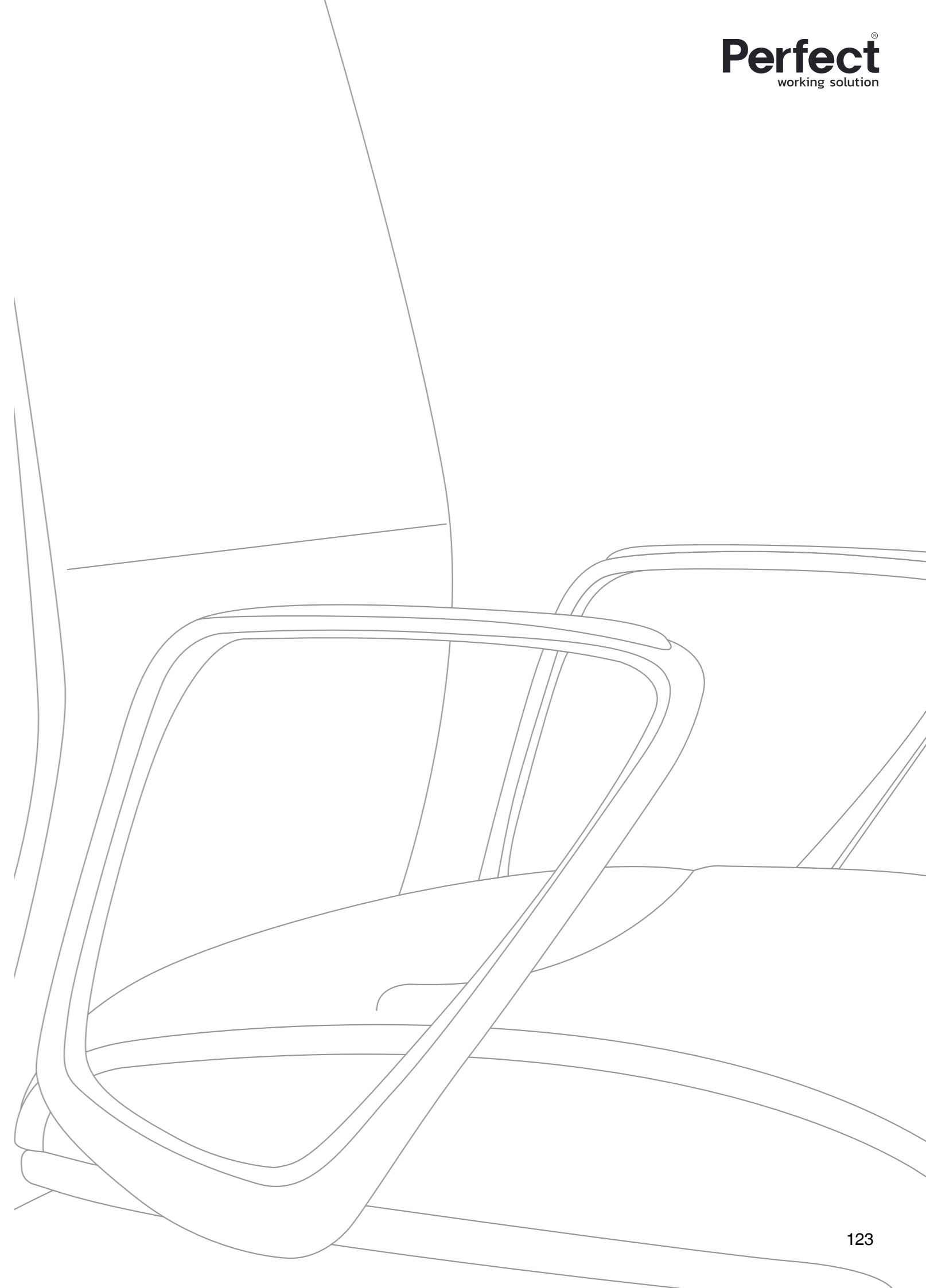

COKES



CE 2
W.124.6 x H.88 x D.63 cm
CE 3
W.191.4 x H.88 x D.63 cm
CE 4
W.258.2 x H.88 x D.63 cm



CE 2/WHT
W.191.4 x H.88 x D.63 cm



CE 2/WTL
W.191.4 x H.88 x D.63 cm
CE 2/WTR
W.191.4 x H.88 x D.63 cm

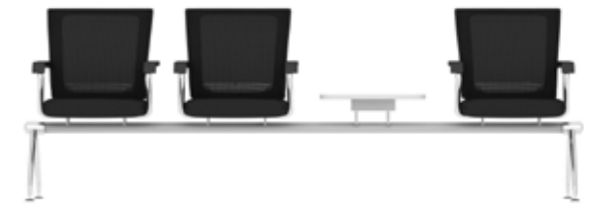

CE 3/WHT
W.258.2 x H.88 x D.63 cm



CE 3/WTL
W.258.2 x H.88 x D.63 cm
CE 3/WTR
W.258.2 x H.88 x D.63 cm



CE 2/LT
W.124.6 x H.88 x D.63 cm
CE 3/LT
W.191.4 x H.88 x D.63 cm
CE 4/LT
W.258.2 x H.88 x D.63 cm



WAITING CHAIRS

HYBRID



HB-01P
W.47 x H.83 x D.51 cm



HB-01/AP
W.56 x H.83 x D.51 cm



HB-01/LP
W.51 x H.83 x D.70 cm

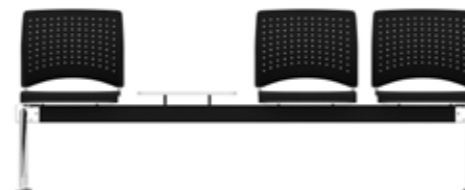

HB-03P/HT
W.217 x H.79.5 x D.61 cm



HBW-03P/LT
W.217 x H.79.5 x D.61 cm
HBW-03P/RT
W.217 x H.79.5 x D.61 cm



HB-02/NAP
W.47 x H.78 x D.55 cm



HB-02/AP
W.56 x H.78 x D.55 cm



HBW-02P
W.101 x H.79.5 x D.61 cm
HBW-03P
W.160 x H.79.5 x D.61 cm
HBW-04P
W.217 x H.79.5 x D.61 cm



HB-TR
W.52.5 x H.36.5 x D.71 cm



HBW-02P/HT
W.160 x H.79.5 x D.61 cm

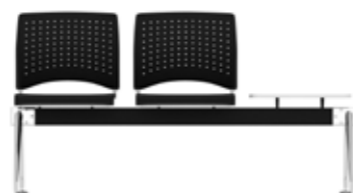

HBW-02P/LT
W.160 x H.79.5 x D.61 cm
HBW-02P/RT
W.160 x H.79.5 x D.61 cm

D-MAX



DM1/C
W.54 x H.85 x D.57 cm



DM1/CA
W.66 x H.85 x D.57 cm



DM1/CL
W.63 x H.85 x D.67 cm



DM3/HT
W.219 x H.81 x D.58 cm



DM3/TL
W.219 x H.81 x D.58 cm
DM3/TR
W.219 x H.81 x D.58 cm



DM1/A
W.61 x H.83 x D.58 cm



DM2
W.105 x H.81 x D.58 cm
DM3
W.162 x H.81 x D.58 cm
DM4
W.219 x H.81 x D.58 cm



DM2/L
W.119 x H.81 x D.61 cm
DM3/L
W.176 x H.81 x D.61 cm
DM4/L
W.233 x H.81 x D.61 cm



DM2/HT
W.162 x H.81 x D.58 cm



DM2/TL
W.162 x H.81 x D.58 cm
DM2/TR
W.162 x H.81 x D.58 cm

FURGY



FG 1
W.52 x H.80x D.53 cm



FG 1/AS
W.58.5 x H.78x D.57 cm



FG 1/NAS
W.50 x H.78x D.57 cm



FG 2/LT
W.168.5 x H.77 x D.55 cm
FG 2/RT
W.168.5 x H.77 x D.55 cm



FG 3/HT
W.227 x H.77 x D.55 cm



FG 1/R
W.50 x H.82 x D.57 cm



FG 1L
W.57 x H.80 x D.72 cm



FG 1L/T
W.57 x H.80 x D.72 cm



FG 3/LT
W.227 x H.77 x D.55 cm
FG 3/RT
W.227 x H.77 x D.55 cm



FG 4/HT
W.285.5 x H.77 x D.55 cm



FG 2
W.110 x H.77 x D.55 cm
FG 3
W.168.5 x H.77 x D.55 cm
FG 4
W.227 x H.77 x D.55 cm
FG 5
W.285.5 x H.77 x D.55 cm



FG 2/HT
W.168.5 x H.77 x D.55 cm



FG 4/LT
W.285.5 x H.77 x D.55 cm
FG 4/RT
W.285.5 x H.77 x D.55 cm

GLIDER



GD 01
W.50 x H.81x D.53 cm



GD 01/A
W.50 x H.81x D.55 cm



GD 01/AC
W.50 x H.81x D.65 cm



GD 02/A (ออฟฟิศ)
W.50 x H.84 x D.59 cm



GD 02/A (ออฟฟิศ)
W.50 x H.84 x D.59 cm



GD 2
W.107.5 x H.78.5 x D.63 cm
GD 3
W.164.5 x H.78.5 x D.63 cm
GD 4
W.221.5 x H.78.5 x D.63 cm



GD 2/HT
W.164.5 x H.78.5 x D.63 cm



GD 2/LT
W.164.5 x H.78.5 x D.63 cm
GD 2/RT
W.164.5 x H.78.5 x D.63 cm



GD 3/HT
W.221.5 x H.78.5 x D.63 cm



GD 2L
W.120 x H.78.5 x D.80 cm
GD 3L
W.177 x H.78.5 x D.80 cm
GD 4L
W.234 x H.78.5 x D.80 cm

BE-NEXT



BN 2
W.110 x H.91 x D.66.5 cm
BN 3
W.195 x H.91 x D.66.5 cm
BN 4
W.220 x H.91 x D.66.5 cm



BN 2/WHT
W.165 x H.91 x D.66.5 cm



BN 2/WTL
W.165 x H.91 x D.66.5 cm
BN 2/WTR
W.165 x H.91 x D.66.5 cm



BN 3/WHT
W.220 x H.91 x D.66.5 cm



BN 3/WTL
W.220 x H.91 x D.66.5 cm
BN 3/WTR
W.220 x H.91 x D.66.5 cm



BN 2/WHT (PU)
W.165 x H.91 x D.66.5 cm

ATLANTA



ATT 2
W.124 x H.89 x D.67.5 cm
ATT 3
W.177 x H.89 x D.67.5 cm
ATT 4
W.240 x H.89 x D.67.5 cm



ATT 2/WHT
W.177 x H.89 x D.67.5 cm



ATT 2/WTL
W.177 x H.89 x D.67.5 cm
ATT 2/WTR
W.177 x H.89 x D.67.5 cm



ATT 3/WHT
W.240 x H.89 x D.67.5 cm



ATT 3/WTL
W.240 x H.89 x D.67.5 cm
ATT 3/WTR
W.240 x H.89 x D.67.5 cm

ATLANTIC



ATL 2
W.121.4 x H.85.5 x D.78.5 cm
ATL 3
W.176.4 x H.85.5 x D.78.5 cm
ATL 4
W.231.4 x H.85.5 x D.78.5 cm



ATL 2/HT/HPL
W.176.4 x H.85.5 x D.78.5 cm



ATL 2/TL/HPL
W.176.4 x H.85.5 x D.78.5 cm
ATL 2/TR/HPL
W.176.4 x H.85.5 x D.78.5 cm



ATL 3/HT/HPL
W.231.4 x H.85.5 x D.78.5 cm



ATL 3/TL/HPL
W.231.4 x H.85.5 x D.78.5 cm
ATL 3/TR/HPL
W.231.4 x H.85.5 x D.78.5 cm

UOB



UOB 2
W.107 x H.80 x D.54.5 cm
UOB 3
W.164 x H.80 x D.54.5 cm
UOB 4
W.221 x H.80 x D.54.5 cm

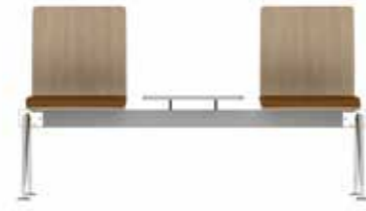

UOB 2/WHT
W.164 x H.80 x D.54.5 cm

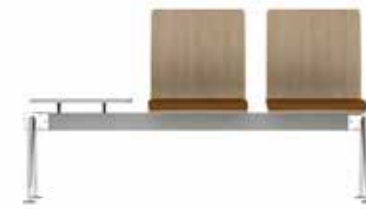

UOB 2/WTL
W.164 x H.80 x D.54.5 cm
UOB 2/WTR
W.164 x H.80 x D.54.5 cm

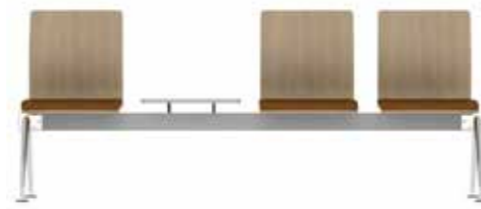

UOB 3/WHT
W.221 x H.80 x D.54.5 cm



UOB 3/WTL
W.221 x H.80 x D.54.5 cm
UOB 3/WTR
W.221 x H.80 x D.54.5 cm

AUDITORIUM



ADN
W.67 x H.100 x D.59 cm



ADN/L
W.67 x H.100 x D.59 cm



ADN/C
W.58 x H.100 x D.59 cm



ADN/CL
W.58 x H.100 x D.59 cm



EP/R, L
W.90 x H.61 x D.41 cm





SOLID/3

W.194 x H.76 x D.84 cm



TB/2

W.158 x H.83 x D.94 cm



P19/3

W.198 x H.78 x D.78 cm



P21/3

W.203 x H.92 x D.93 cm



SOLID/2

W.143 x H.76 x D.84 cm



TB/1

W.88 x H.83 x D.87 cm



P19/2

W.143 x H.78 x D.78 cm



P21/1

W.102 x H.92 x D.93 cm



SOLID/1

W.91 x H.76 x D.84 cm



P19/1

W.89 x H.78 x D.78 cm



PASSION/3

W.185 x H.78 x D.74 cm



P22/3

W.196 x H.79 x D.81 cm



BESTA/3

W.193 x H.73 x D.75 cm



P24/3

W.168 x H.88 x D.78 cm



PASSION/2

W.133 x H.78 x D.74 cm



P22/2

W.146 x H.79 x D.81 cm



BESTA/2

W.140 x H.73 x D.75 cm



P24/1

W.73 x H.88 x D.78 cm



PASSION/1

W.81 x H.78 x D.74 cm



P22/1

W.95 x H.79 x D.81 cm



BESTA/1

W.88 x H.73 x D.75 cm



P28/3

W.173 x H.83 x D.67 cm



P23/3

W.195 x H.87 x D.74 cm



P27/3

W.186 x H.77 x D.80 cm



Black Brown White

SQUARE

W.67 x H.78 x D.60 cm



P28/2

W.127 x H.83 x D.67 cm



P23/2

W.136 x H.87 x D.74 cm



P27/1

W.81 x H.77 x D.80 cm



Black White

UN1

W.56 x H.74 x D.74 cm



P28/1

W.72 x H.83 x D.67 cm



P23/1

W.77 x H.87 x D.74 cm



MARY

W.70 x H.70 x D.70 cm



Brown Black White Purple Cream

MINI BOSTON

W.66 x H.80 x D.67 cm



CUBIC/3

W.182 x H.72 x D.66 cm



CUBIC/CN

W.66 x H.72 x D.66 cm



CUBIC/2

W.131 x H.72 x D.66 cm



CUBIC/CT

W.66 x H.72 x D.66 cm



CUBIC/1

W.82 x H.72 x D.66 cm



CUBIC/ST

W.66 x H.44 x D.66 cm

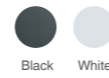

COLLAR

W.82 x H.78 x D.75 cm



FANTASY

W.62 x H.75 x D.56 cm



SHAPELY

W.72 x H.84.5 x D.60 cm



STRIPS

W.59 x H.74 x D.66 cm



OP-WOOD/3

W.183 x H.73 x D.71 cm



NBCT-9060

W.90 x H.40 x D.60 cm



NBCT-6060

W.60 x H.40 x D.60 cm



CBCT-9060

W.90 x H.41 x D.60 cm



CBST-6060

W.60 x H.41 x D.60 cm



T16

W.90 x H.40 x D.60 cm



T17

W.60 x H.40 x D.60 cm



T11

W.90 x H.42 x D.60 cm



T10

W.60 x H.42 x D.60 cm



SG1

W.60 x H.40 x D.60 cm



TIMELINE/B

W.105 x H.47 x D.60 cm



TIMELINE/S

W.60 x H.47 x D.60 cm



SHINE/S

W.60 x H.41 x D.60 cm



SHINE/B

W.90 x H.41 x D.60 cm



T3

W.90 x H.40 x D.60 cm



T4

W.60 x H.40 x D.60 cm



TG4

W.90 x H.38 x D.60 cm



TG3

W.60 x H.38 x D.60 cm



JACOB

R.50 x H.60 cm



FRANCE/H PU
W.63.5 x H.116 x D.67.5 cm



FRANCE/H MESH
W.63.5 x H.116 x D.67.5 cm



A1186
W.61 x H.106 x D.60 cm



ZOKO/SCB
W.61 x H.91.5 x D.54.5 cm



FRANCE/M PU
W.63.5 x H.97 x D.63 cm



FRANCE/M MESH
W.63.5 x H.97 x D.63 cm



B1186
W.61 x H.91 x D.60 cm



W100/10
W.65 x H.99 x D.58 cm



TENDER/H
BIFMA
W.65 x H.113 x D.61 cm



CKF 6013A
W.60 x H.126 x D.66 cm



CUP
W.57 x H.85 x D.56 cm



GENIUS
W.61 x H.95 x D.57 cm



TENDER/M
BIFMA
W.65 x H.98 x D.58 cm



CKF 6013B
W.60 x H.102 x D.63 cm



TAKE OFF/FP
W.62 x H.91 x D.60 cm



TAKE OFF/FU
W.62 x H.91 x D.60 cm



TENDER/ECONOMY
BIFMA
W.65 x H.99 x D.56 cm



HJ-033A
W.62 x H.120 x D.67 cm



TAKE OFF/PU
W.62 x H.91 x D.60 cm



TAKE OFF/PP
W.62 x H.91 x D.60 cm



6616B
BIFMA
W.62 x H.100 x D.63 cm



HJ-033B
W.62 x H.95 x D.67 cm



ZM-411AL-2

W.66 x H.112-122 x D.65-70 cm



6206A

W.67 x H.116-126 x D.62 cm



Q1-2BH

W.61 x H.106 x D.60 cm



X-CROSS

W.60 x H.54.5 x D.82.5 cm



ZM-411BL-2

W.66 x H.98-108 x D.61-66 cm



6206B

W.67 x H.96-106 x D.62 cm



Q1-2B

W.61 x H.91 x D.60 cm



BOOM BOOM

W.38 x H.49-68 x D.38cm



ZM-411A-2

W.66 x H.118-128 x D.65-70 cm



VECO/H

W.63-88 x H.121-134 x D.44.5-49 cm



SK3098A

W.63 x H.116 x D.57 cm



ZM-411B-2

W.65.5 x H.98-108 x D.62.5 cm



VECO/M

W.63-88 x H.105-117 x D.44.5-49 cm



SK3098B

W.63 x H.99 x D.57 cm



6042A

W.65 x H.110-117 x D.64 cm



EZ08E

W.66 x H.116.5 x D.58 cm



ERI-E001A

W.65 x H.116-124 x D.60 cm



6042B

W.65 x H.93-103 x D.62 cm



EZ08F

W.66 x H.98.5 x D.58 cm



ERI-E001B

W.65 x H.98-106 x D.60 cm



LG12/H

W.67 x H.114 x D.75 cm



LG13/H

W.69 x H.123 x D.70 cm



RR5/HS

W.63 x H.120 x D.66cm



RR5/AS

W.60 x H.95 x D.64 cm



LG12/M

W.67 x H.98 x D.75 cm



LG13/M

W.69 x H.103 x D.70 cm



RR5/MS

W.63 x H.100 x D.60 cm



RR5/CS

W.59 x H.102 x D.70cm



LG9/H

W.69 x H.118 x D.69 cm



OK/H

W.59 x H.110 x D.67cm



FF02/H

W.62 x H.114 x D.68 cm



FF01/A

W.57 x H.87 x D.62 cm



LG9/A

W.67 x H.97 x D.73 cm



OK/M

W.55 x H.90 x D.63 cm



FF02/M

W.62 x H.96 x D.68 cm



FF01

W.47 x H.87 x D.62 cm



OS/H

W.63 x H.112 x D.65cm



LM/H

W.56 x H.112 x D.66cm



FF01/C

W.57 x H.89 x D.62 cm



OS/L

W.63 x H.85 x D.65 cm



LM/M

W.56 x H.97 x D.66cm



SR4/AC

W.62 x H.114 x D.70 cm



SR2/AC

W.58 x H.86 x D.62 cm



NEYMAR/HC

W.67 x H.120 x D.61cm



NEYMAR/LC

W.65 x H.89 x D.61 cm



SR3/AC

W.60 x H.94 x D.66 cm



SR1/AC

W.52 x H.89 x D.62 cm



NEYMAR/MC

W.67 x H.98 x D.61 cm



NEYMAR/LCN

W.49 x H.89 x D.61cm



SR1/CC

W.58 x H.84 x D.62 cm



RL1/H

W.66 x H.112 x D.75 cm



NEYMAR/C

W.57 x H.94 x D.65cm



NEYMAR/HP

W.67 x H.120 x D.61cm



RL1/A

W.62 x H.85 x D.70 cm



RL1/C

W.64x H.89x D.64 cm



NEYMAR/MP

W.67 x H.98 x D.61 cm



NEYMAR/LP

W.65 x H.89 x D.61 cm



NEYMAR/LPN

W.49 x H.89 x D.61cm



FR/H

W.64 x H.116 x D.67 cm



FR/M

W.64 x H.99 x D.66 cm

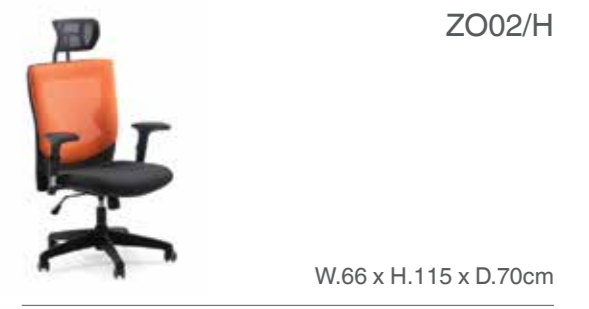
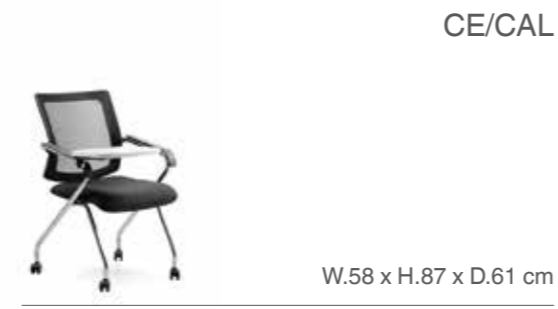
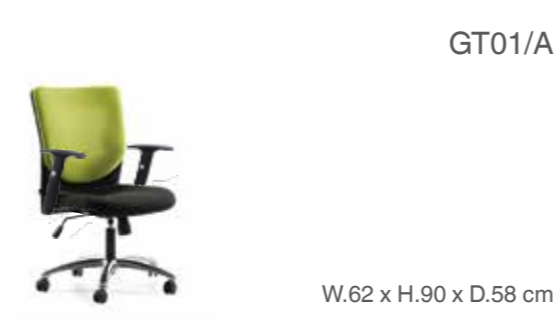



SE/HC

W.63 x H.121 x D.68 cm



SE/LC

W.55 x H.85 x D.61 cm



PD/H

W.66 x H.113 x D.58 cm



PD/L

W.63 x H.88 x D.58 cm



SE/MC

W.63 x H.102 x D.68 cm



SE/LCN

W.49 x H.85 x D.61 cm



PD/M

W.66 x H.101 x D.59 cm



PD/LN

W.50 x H.88 x D.58 cm



SE/CC

W.57 x H.83 x D.60 cm



SE/HP

W.63 x H.121 x D.68 cm



PD/C

W.50 x H.88 x D.58 cm



SE/MP

W.63 x H.102 x D.65 cm



SE/LPN

W.49 x H.85 x D.61 cm



SE/LP

W.55 x H.85 x D.61 cm



SE/C

W.57 x H.83 x D.60 cm



ISO 14001:2015
E5902

Perfect Working Solution

Email
info@perfect-furniture.com

Web
www.perfect-furniture.com

Headoffice

BKK
196 Rama 2 Road
Samaedam, Bangkhunthien
Bangkok 10150 Thailand
T: +66 2895 6301-7
F: +66 2416 0997
+66 2895 7961

Showrooms

MBK Center
5 Fl. Zone 2
444 Phayathai Road
Patumwan, Bangkok
10330 Thailand
T: +66 2853 9278-79
F: +66 2853 9277

CDC
1 Fl. Building F 106-107
1420/1 Praditmanutham
Road, Klongjun, Bangkok
10240 Thailand
T: +66 2102 2340
F: +66 2102 2341

Showrooms

CENTRAL CITY BANGNA
4 Fl. 1090 Moo 12
Bangna-Trad Road, Bangna
Bangkok 10240 Thailand
T: +66 2361 1003
+66 2399 3819
F: +66 2361 1004

SECON SQUARE
3 Fl. 55 Srinakarin Road
Nongbon, Prawet
Bangkok 10250
Thailand
T: +66 2721 9315
F: +66 2721 9314

Showrooms

CENTRAL PLAZA RAMA 2
3 Fl. 160 Rama 2 Road
Samaedam, Bangkhunthien
Bangkok 10150
Thailand
T: +66 2872 4596
F: +66 2872 4597

RATCHAPHRUEK
90, 90/1 Ratchapruerk Road,
Bang Ramad, Talingchan
Bangkok 10170
Thailand
T: +66 2403 1577
F: +66 2403 1576